



**TALENT**  
S U R G I C A L



# TALENT HOLLOWWARE SURGICAL INSTRUMENTS

We make more than 1385 surgical instruments.

We are proud to manufacture premium quality instruments.



## Certification:



Registered with Therapeutic Goods Australia (Scissors)  
Registered with Therapeutic Goods Australia (Needle Holder)  
Registered with Therapeutic Goods Australia (Forceps)

[www.tsurgicalinstruments.com](http://www.tsurgicalinstruments.com)



**TSI-2948**  
Instruments Tray of 20 Pcs

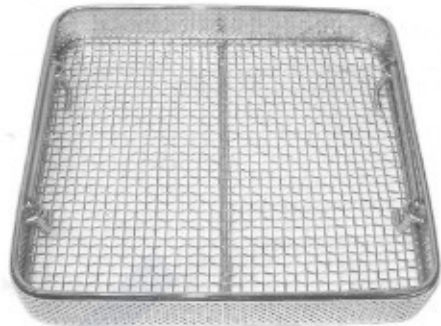

**TSI-2951**  
Instruments Riddle



**TSI-2949**  
Instruments Tray of 7 Pcs



**TSI-2949-A**  
Instruments Tray of 10 Pcs



**TSI-2950**  
Instruments Tray of 5 Pcs

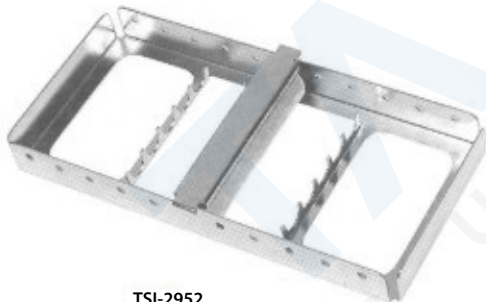

**TSI-2952**  
Instruments Tray of 5 Pcs

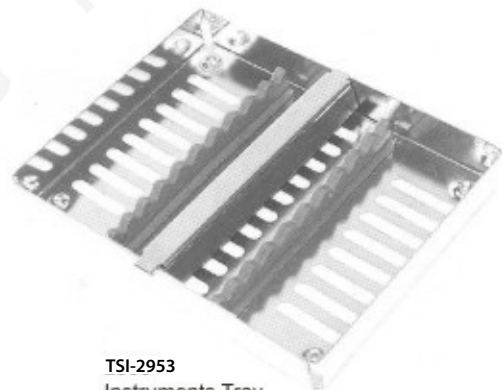

**TSI-2953**  
Instruments Tray



**TSI-2954**  
Instruments Tray  
Perforated



**TSI-2956**  
Instruments Tray  
Perforated Base



**TSI-2956**  
Instruments Tray  
Solid Base



**TSI-2957**  
Pulpectomy Tray



**TSI-2958**  
Sterilizing Box  
Available Sizes:  
17x17x3 cm  
20x10x6 cm  
30x14x6 cm



**TSI-2959**  
Endo Tray Box



**TSI-2960**  
Finger Cup



**TSI-2960**  
Bur Box

**TSI-2962**  
Sterilizing Drum  
150x150mm  
175x175mm  
190x190mm  
200x140mm  
200x200mm  
240x120mm  
225x225mm  
240x240mm  
290x160mm



**TSI-2963**  
Sterilizing Drum  
280x240mm  
230x150mm  
300x250mm  
340x160mm  
350x250mm  
390x200mm  
380x300mm  
100x100mm  
150x120mm





TSI-2964  
Instruments Box



TSI-2965  
Instruments Box



TSI-2966  
Instruments Box



TSI-2967  
Instruments Sterilizer  
150x75 mm



TSI-2968  
Endodontic Box



TSI-2969  
Sterilizing Box  
320x120 mm



TSI-2970  
Instruments Tray



TSI-2971  
Instruments Tray



TSI-2972  
Instruments Tray  
(Perforated)



TSI-2973  
Instruments Tray  
Shallow(Mayo)



TSI-2974  
Scaler Tray  
20.0 x 10.0 x 1.5 cm



TSI-2975  
Scalers Tray



TSI-2976  
Scalers Tray



TSI-2977

TSI-2978

TSI-2979

TSI-2980

Forcep and Thermometer Jars

TSI-2981

Cotton Holding Jar  
60x50 mm



TSI-2982  
Spitten Mug



TSI-2983  
Spirit Burner With Wick  
Stainless Steel 18/10  
Capacity: 150 ml, 60 ml



TSI-2984  
Spirit Burners With Wick  
Stainless Steel 18/10  
Capacity: 70ml



TSI-2985  
Dressing Jar



TSI-2986  
Dressing Jar



TSI-2987  
Irrigator(Douch Can)



TSI-2988  
Measuring Jug



TSI-2989  
Sponge Bowl



TSI-2990  
Wash Basin  
300mm-350mm-400mm



TSI-2994  
Kick Bucket With Trolley



TSI-2991  
Sponge Bowl



TSI-2992  
Gallipot



TSI-2993  
Medicine Cup



TSI-2995  
Kidney Tray Shallow  
150mm-200mm-240mm-300mm



TSI-2996  
Kidney Tray Without Lid  
150mm-200mm-250mm-300mm



TSI-2997  
Kidney Tray With Lid  
150mm-200mm-250mm-300mm

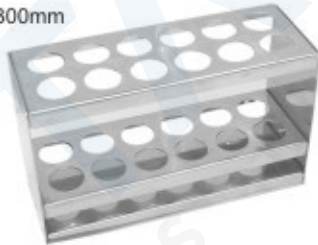

TSI-2998  
Tube Rack, Stainless Steel 18/10



TSI-2999  
Needle Case Rectangle  
Needle Case Round With Cover  
90x15



TSI-3000  
Dustbin Without Stand  
6-10-12 Ltr



TSI-3001  
Tube Rack, Round Model  
Stainless Steel 18/10



TSI-3002  
Dustbin Without Stand & Cap  
6-10-12 Ltr



TSI-3003  
Lotion Bowl With Lip  
40-60-80-100-120-150-18



TSI-19-101-115  
Schimmelbusch

	Ø x H sizes in mm
19-101	80 x 80
19-102	105 x 120
19-103	140 x 140
19-104	160 x 120
19-105	160 x 150
19-106	190 x 150
19-107	190 x 190
19-108	240 x 160
19-109	240 x 240
19-110	290 x 160
19-111	290 x 240
19-112	340 x 160
19-113	340 x 340
19-114	390 x 190
19-115	390 x 290



TSI-19-116  
Box  
120 x 65 x 13mm  
(without Bulldog clamps,  
without silicone tape)



TSI-19-117  
Box with support  
120 x 65 x 13 mm  
(ohne Bulldogklemmen)



TSI-19-118  
Box with support for  
needle electrodes,  
without instruments

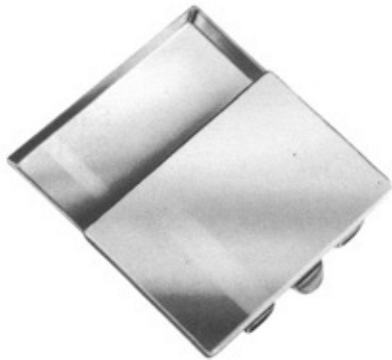

TSI-19-119-121  
50 x 25 x 4,5 mm  
19-120  
65 x 42 x 8 mm  
19-121  
75 x 25 x 4,5 mm



TSI-19-122  
Ø 65mm x 15mm



TSI-19-123-131

	Ø x H
19-123	30 x 90 mm
19-124	50 x 100 mm
19-125	50 x 130 mm
19-126	50 x 175 mm
19-127	75 x 100 mm
19-128	75 x 130 mm
19-129	75 x 175 mm
19-130	100 x 175 mm
19-131	100 x 200 mm



TSI-19-141-142

- 19-141** Martin Sterilizing Forceps consisting of:  
1 Sterilizing Forceps, curved, 25 cm, without ratchet, with lid for jar  
1 jar with bottom plate (anti-tilt)
- 19-142** ditto, with 32 cm long Sterilizing Forceps



TSI-19-132-139

19-132	165 x 85 x 35 mm
19-133	200 x 100 x 35 mm
19-134	200 x 100 x 50 mm
19-135	230 x 130 x 50 mm
19-136	260 x 150 x 50 mm
19-137	270 x 235 x 50 mm
19-138	300 x 200 x 50 mm
19-139	325 x 275 x 50 mm



TSI-19-140  
205 x 105 x 35 mm





TSI-19-143-148

	Ø x H
19-143	75 x 60 mm
19-144	75 x 75 mm
19-145	100 x 60 mm
19-146	100 x 100 mm
19-146A	125 x 80 mm
19-147	125 x 125 mm
19-148	150 x 150 mm



TSI-19-149  
25 cc

TSI-19-150  
50 cc



TSI-19-151  
20 cc  
Medicine Spoon



TSI-19-152  
Ø 75 x 12 mm  
Tablet Tray



TSI-19-153  
Ø 90 x 90 mm  
Metal Cup



TSI-19-154  
Ø 75 x 80 mm  
Sputum Cup

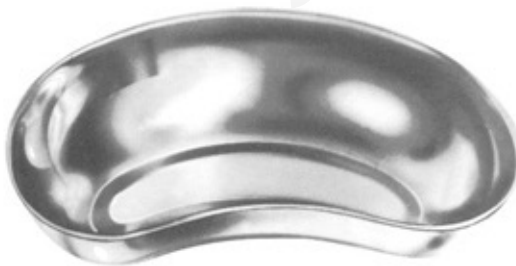

**Kidney Dish**



TSI-19-155-157

19-155	170 x 100 x 35 mm
19-156	250 x 140 x 40 mm
19-157	275 x 150 x 45 mm



TSI-19-158-165



TSI-19-166-170

	Ø x H	
19-158	40 x 19 mm	0.05L
19-159	61 x 30 mm	0.07L
19-160	80 x 40 mm	0.14L
19-161	116 x 50 mm	0.35L
19-162	128 x 55 mm	0.45L
19-163	147 x 65 mm	0.70L
19-164	167 x 75 mm	1.10L
19-165	187 x 85 mm	1.60L

19-166	116 x 35 mm	0.30L
19-167	128 x 38 mm	0.40L
19-168	147 x 40 mm	0.50L
19-169	157 x 45 mm	0.75L
19-170	187 x 45 mm	1.00L



TSI-19-171  
Ø 110 x 28 mm 0.15L



TSI-19-172  
100 cc 0.1L



TSI-19-173-176  
19-173 0,25L  
19-174 0,50L  
19-175 1,00L  
19-176 2,00L



TSI-19-177  
235 x 190 x 40 mm



TSI-19-178  
Ø 220 x 70 mm





TSI-19-179  
∅ 50 x 100 mm  
Powder Pot



TSI-19-180  
∅ 50 x 75 mm  
Methot With Lid



TSI-19-181  
∅ 50 x 75 mm  
Methot Without Lid



TSI-19-182



TSI-19-183



TSI-19-184



TSI-19-185-186

19-185 ∅ 235 mm  
19-186 ∅ 310 mm



TSI-19-187  
Sauerbruch  
210 x 125 x 17 mm



TSI-19-188  
Sauerbruch  
210 x 125 x 17 mm



TSI-19-189  
150 x 95 x 13 mm



TSI-19-190  
150 x 95 x 13 mm



TSI-19-191  
150 x 95 x 13 mm



TSI-19-192  
150 x 95 x 13 mm



TSI-19-193  
150 x 95 x 13 mm



TSI-19-194  
150 x 95 x 13 mm



TSI-19-195  
150 x 95 x 11 mm





TSI-19-199-209

19-199	230 x 130 x 50	mm
19-200	260 x 150 x 50	mm
19-201	275 x 235 x 50	mm
19-202	300 x 200 x 50	mm
19-203	325 x 275 x 50	mm
19-204	420 x 175 x 50	mm
19-205	230 x 130 x 75	mm
19-206	260 x 150 x 75	mm
19-207	300 x 200 x 75	mm
19-208	325 x 275 x 75	mm
19-209	420 x 175 x 75	mm



TSI-19-196  
Deponette  
245 x 135 x 35mm



TSI-19-197  
Deponette  
245 x 135 x 50mm



TSI-19-198  
Deponette  
245 x 135 x 60mm

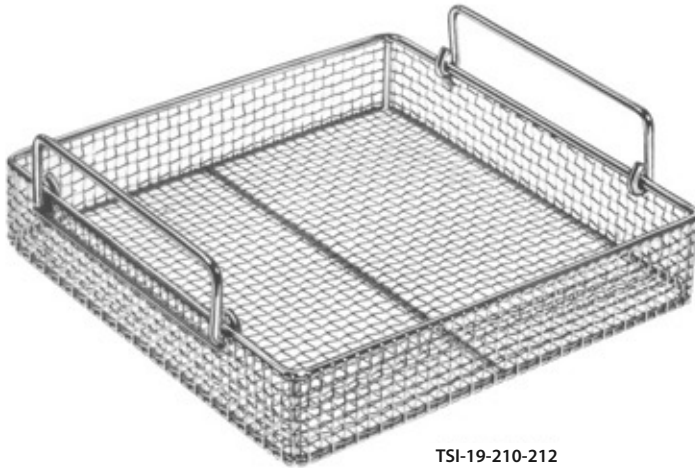

TSI-19-210-212

19-210	480 x 250 x 50	mm
19-211	520 x 250 x 75	mm
19-212	520 x 250 x 100	mm

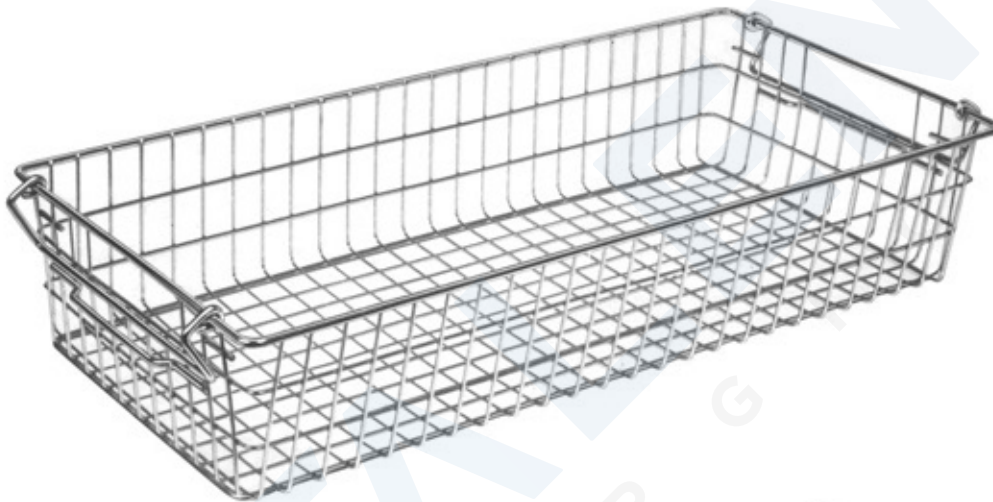

TSI-19-219  
(60 x 30 x 15 cm)  
Nominal dimensions



TSI-19-213-218

19-213	240 x 240 x 50	mm
19-214	240 x 240 x 80	mm
19-215	240 x 240 x 100	mm
19-216	480 x 260 x 50	mm
19-217	520 x 260 x 80	mm
19-218	520 x 260 x 100	mm





### **Sialkot, Pakistan Office**

Contact Person: Hasham khalid



Address: A/1, Small Industries Estate, Near SIE Telephone Exchange PTCL, Sialkot – Punjab 51310, Pakistan.



Yakshan Khalid: +92 331 478 6083



info@tsurgicalinstruments.com  
Talentsurgicalaustralia@gmail.com



### **Australia Office:**

Contact Person: Hasham khalid



Pelham Crescent, Wyndham Vale, VIC 3024 Australia



Hasham Khalid: +61 430 855 424 / +61 481 335 786



info@tsurgicalinstruments.com  
Talentsurgicalaustralia@gmail.com



**TALENT**  
S U R G I C A L

