



TALENT
S U R G I C A L



OPHTHALMIC / EYE SURGICAL INSTRUMENTS

We make more than 1385 surgical instruments.

We are proud to manufacture premium quality instruments.

Certification:



Registered with Therapeutic Goods Australia (Scissors)
Registered with Therapeutic Goods Australia (Needle Holder)
Registered with Therapeutic Goods Australia (Forceps)

www.tsurgicalinstruments.com



TALENT

S U R G I C A L





Eye

Scissors	004 - 020
Micro Needle Holders	021 - 023
Forceps	024 - 036
Specula	037 - 039
Hooks and Retractors	040 - 041
Hooks / Retractors / Manipulators	042 - 053
Fixation Rings and Markers	054 - 056
Probes and Dilators	057 - 059
Lacrimal Intubation Sets	060 - 061
Cannulas	062 - 068
Miscellaneous	069



TSI04, TSI02-TSI06, TSI01



TSI01

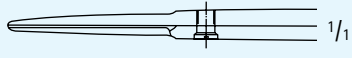

TSI03

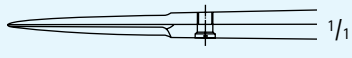

TSI02



TSI04

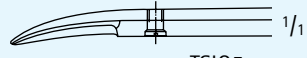

TSI05

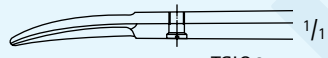

TSI06

Iris Scissors

Catalog Number	Tip	Blade	Handle	Length (in.)
TSI01	S/S	STR	RIBBON	4
TSI02	S/S	STR	RIBBON	4 1/4
TSI03	B/B	STR	RIBBON	4 1/4
TSI04	S/S	CVD	RIBBON	4
TSI05	S/S	CVD	RIBBON	4 1/4
TSI06	B/B	CVD	RIBBON	4 1/4
TSI07	S/S	STR	SQUARE	4 1/2
TSI08	S/S	CVD	SQUARE	4 1/2

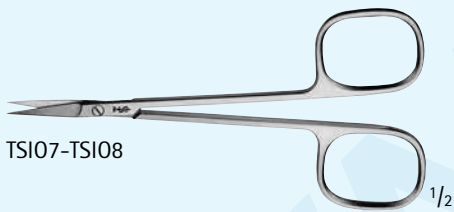

TSI07-TSI08

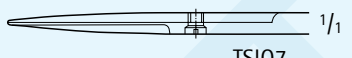

TSI07

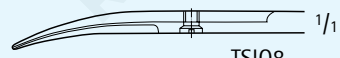

TSI08

Iris Scissors (continued)

Catalog Number	Tip	Blade	Handle	Length (in.)
TSIO9	S/S	STR	ROUND	3 1/2
TSIO10	S/S	STR	ROUND	3 3/4
TSIO11	S/S	STR	ROUND	4 1/8
TSIO12	S/S	STR	ROUND	4 1/4
TSIO13	S/B	STR	ROUND	4 1/4
TSIO14	S/S	STR	ROUND	4 1/2
TSIO15	S/S	STR	ROUND	4 3/4
TSIO16	S/S	CVD	ROUND	3 1/2
TSIO17	S/S	CVD	ROUND	3 3/4
TSIO18	S/S	CVD	ROUND	4 1/8
TSIO19	S/S	CVD	ROUND	4 1/4
TSIO20	S/B	CVD	ROUND	4 1/4
TSIO21	S/S	CVD	ROUND	4 1/2
TSIO22	S/S	CVD	ROUND	4 3/4
TSIO23	S/S	LAT-ANG	ROUND	4 1/4
TSIO24	S/S	STR	ROUND, CENTERED	4 1/4

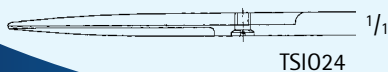
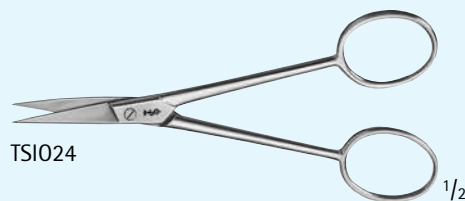
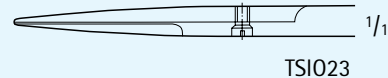
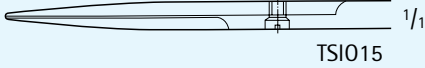
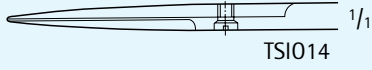
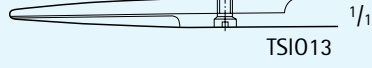
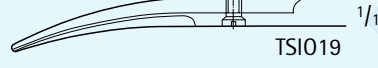
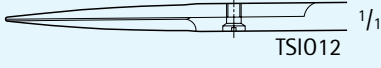
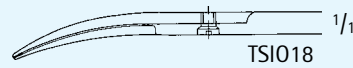
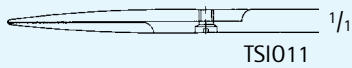
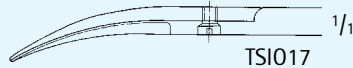
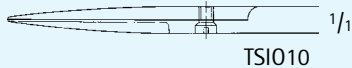
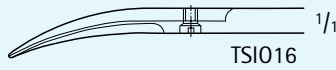
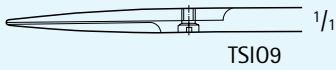
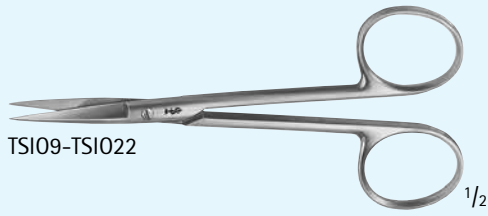

STEVENS Tenotomy Scissors

Catalog Number	Tip	Blade	Handle	Length (in.)
TSIO25	S/S	STR	RIBBON	4
TSIO26	B/B	STR	RIBBON	3 3/4
TSIO27	B/B	STR	RIBBON	3 7/8
TSIO28	B/B	CVD	RIBBON	3 3/4
TSIO29	S/S	CVD	RIBBON	4
TSIO30	B/B	CVD	RIBBON	4 1/4
TSIO31	S/S	STR	SQUARE	4 1/2
TSIO32	B/B	STR	SQUARE	4 1/2
TSIO33	S/S	CVD	SQUARE	4 1/2
TSIO34	B/B	CVD	SQUARE	4 1/2



TSIO27-TSIO26

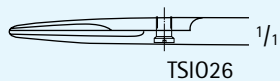

TSIO26

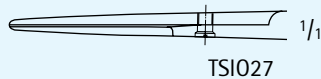

TSIO27

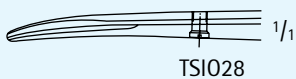

TSIO28



TSIO25-TSIO29

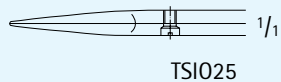

TSIO25

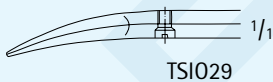

TSIO29

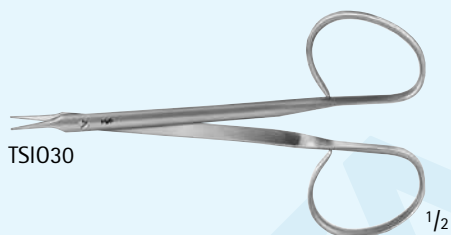

TSIO30

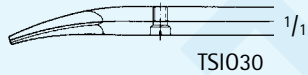

TSIO30

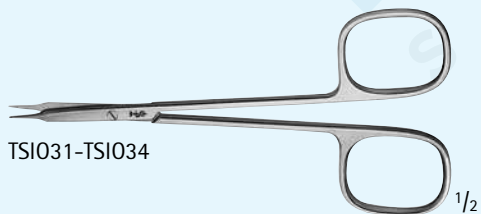

TSIO31-TSIO34

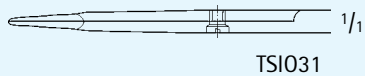

TSIO31

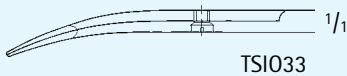

TSIO33

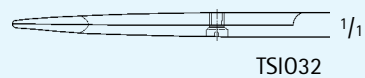

TSIO32



TSIO34

STEVENS Tenotomy Scissors
(continued)

Catalog Number	Tip	Blade	Handle	Length (in.)
TSIO35	S/S	STR	ROUND	4 1/4
TSIO36	B/B	STR	ROUND	4 1/4
TSIO37	B/B	STR	ROUND	5
TSIO38	B/B	STR	ROUND	5 3/4
TSIO39	S/S	CVD	ROUND	4 1/4
TSIO40	B/B	CVD	ROUND	4 1/4
TSIO41	B/B	CVD	ROUND	5
TSIO42	B/B	CVD	ROUND	5 3/4

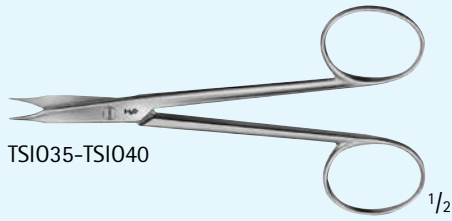

TSIO35-TSIO40

1/2

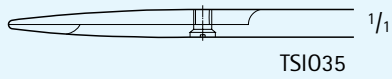

TSIO35

1/1

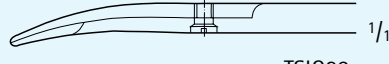

TSIO39

1/1

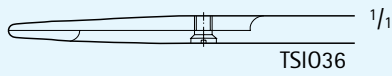

TSIO36

1/1

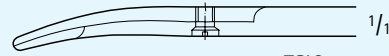

TSIO40

1/1

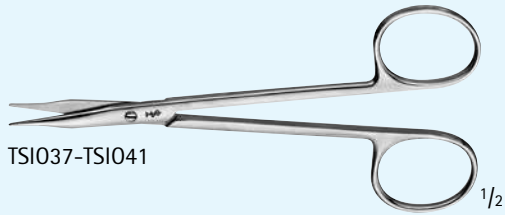

TSIO37-TSIO41

1/2

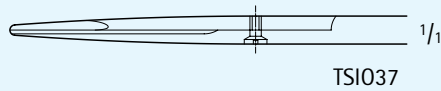

TSIO37

1/1

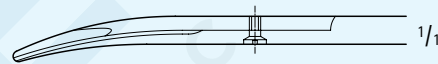

TSIO41

1/1

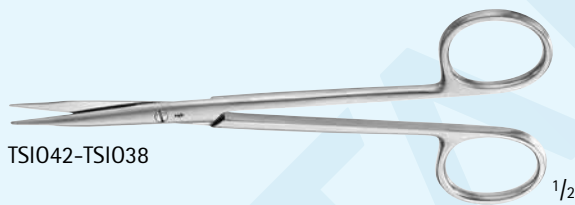

TSIO42-TSIO38

1/2

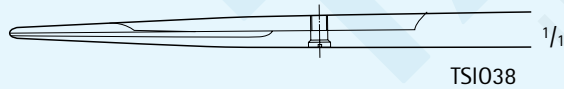

TSIO38

1/1

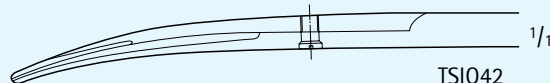

TSIO42

1/1

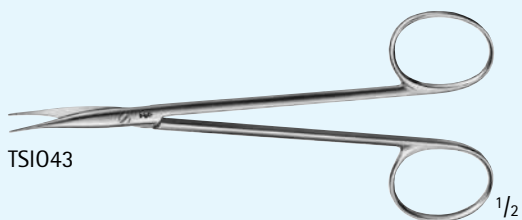

TSIO43

1/2

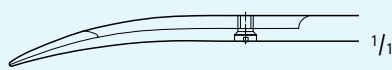

TSIO43

1/1

JAMESON-WERBER Tenotomy Scissors

Catalog Number	Tip	Blade	Length (in.)
TSIO43	B/B	DEL, CVD	5 1/8

Strabismus Scissors, Delicate

Catalog Number	Tip	Blade	Handle	Length (in.)
TSIO44	B/B	CVD	RIBBON	4 1/4
TSIO45	B/B	STR	SQUARE	4 1/2
TSIO46	B/B	CVD	SQUARE	4 1/2
TSIO47	B/B	STR	ROUND	4 1/2
TSIO48	B/B	CVD	ROUND	4 1/2

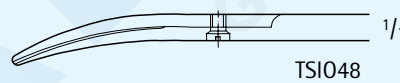
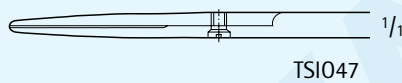
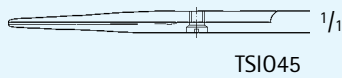
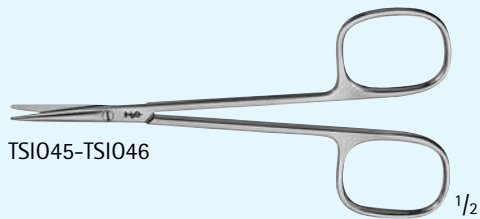
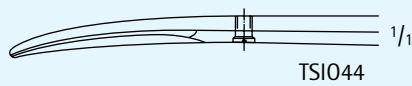
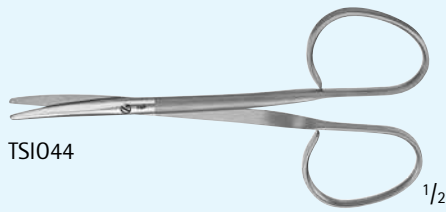

KNAPP Strabismus Scissors, Delicate

Catalog Number	Tip	Blade	Length (in.)
TSIO49	B/B	STR	4 3/4
TSIO50	B/B	CVD	4 3/4

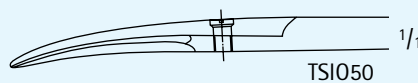
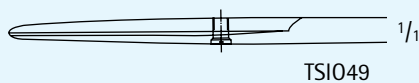
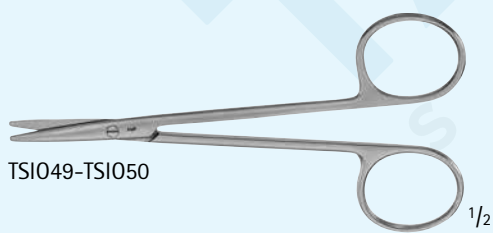

Enucleation Scissors

Catalog Number	Tip	Blade	Length (in.)
TSIO51	B/B	SLIGHT CVD	5
TSIO52	B/B	MEDIUM CVD	5 1/4
TSIO53	B/B	FULL CVD	5 1/8



TSIO51, TSIO52, TSIO53



TSIO51

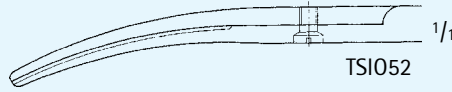

TSIO52



TSIO53

Eye Scissors

Catalog Number	Tip	Blade	Length (in.)
TSIO54	PROBE	ANG	4 1/2

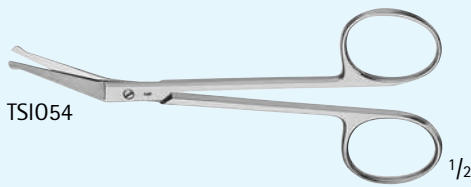

TSIO54

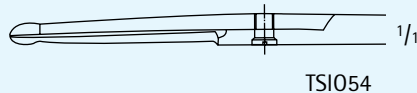

TSIO54

Utility Scissors, Ribbon Handle

Catalog Number	Tip	Blade	Length (in.)
TSIO55	B/B	STR	4
TSIO56	B/B	CVD	4
TSIO57	B/B	CVD	4



TSIO55-TSIO57

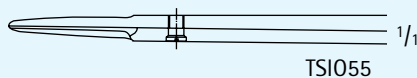

TSIO55

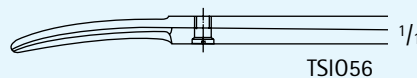

TSIO56

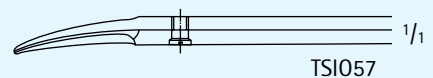

TSIO57

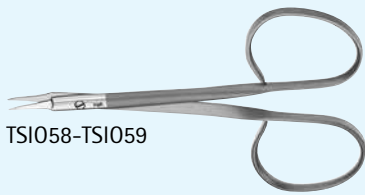

TSI058-TSI059

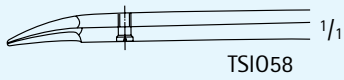

TSI058

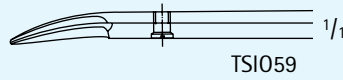

TSI059

Stitch Scissors, Ribbon Handle

Catalog Number	Tip	Blade	Length (in.)
TSI058	S/S	CVD	3 3/4
TSI059	S/S	CVD	4 3/4



TSI060



TSI060

Stitch Scissors

Catalog Number	Tip	Blade	Length (in.)
TSI060	S/S	STR	4



TSI061



TSI061

WILMER Conjunctival Scissors

Catalog Number	Tip	Blade	Length (in.)
TSI061	S/S	ANG-FLAT	4 1/8

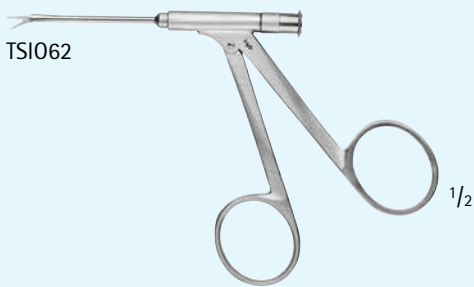

TSI062

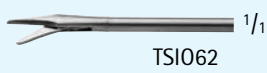

TSI062

IOL Cutter

Catalog Number	Blade	Blade Length (mm)	Diameter (mm)	Length (in.)
TSI062	SERR	6	2	4 1/2

DUROTIP Tungsten Carbide (TC) Scissors

- Excellent cutting accuracy
- Long working life
- Gold-plated rings

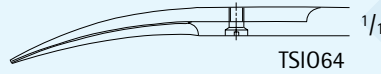
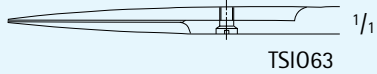

DUROTIP TC Iris Scissors, Delicate

Catalog Number	Tip	Blade	Length (in.)
TSIO63	S/S	STR	4 1/4
TSIO64	S/S	CVD	4 1/4

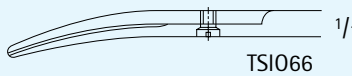
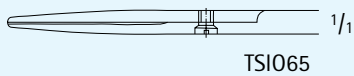

DUROTIP TC Strabismus Scissors, Delicate

Catalog Number	Tip	Blade	Length (in.)
TSIO65	B/B	STR	4 1/2
TSIO66	B/B	CVD	4 1/2



Wavecut

■ Wavecut scissors have one serrated cutting edge to help prevent tissue from slipping. The W after the item number indicates the scissors are the wavecut style, e.g. BC211W.

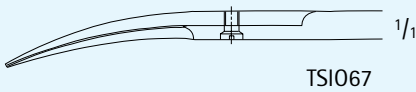
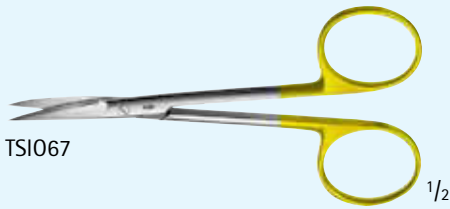

DUROTIP TC Iris Scissors, Wavecut

Catalog Number	Tip	Blade	Length (in.)
TSI067	S/S	CVD	4 1/4

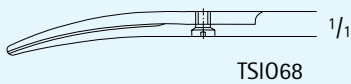

DUROTIP TC Strabismus Wavecut Scissors

Catalog Number	Tip	Blade	Length (in.)
TSI068	B/B	CVD	4 1/2



TSI069-TSI071

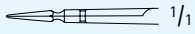

TSI069

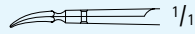

TSI070

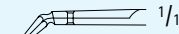

TSI071

VANNAS Micro Scissors

Catalog Number	Tip	Blade	Handle	Length (in.)
TSI069	S/S	STR	FLAT, SERR	3 1/4
TSI070	S/S	CVD	FLAT, SERR	3 1/4
TSI071	S/S	ANG	FLAT, SERR	3 1/4



TSI072-TSI074



TSI072

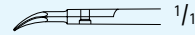

TSI073



TSI074

VANNAS Micro Scissors

Catalog Number	Tip	Blade	Handle	Length (in.)
TSI072	S/S	STR	FLAT, SERR	4 3/4
TSI073	S/S	CVD	FLAT, SERR	4 3/4
TSI074	S/S	ANG	FLAT, SERR	4 3/4
TSI075	S/S	STR	FLAT, SERR	6 1/4
TSI076	S/S	CVD	FLAT, SERR	6 1/4

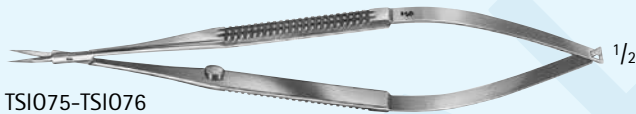

TSI075-TSI076

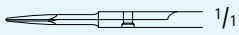

TSI075



TSI076

VANNAS Micro Scissors, Wide Handle

Catalog Number	Tip	Tip Size (mm)	Blade	Handle	Length (in.)
TSI077	S/S	10	CVD	FLAT, WIDE SERR	4 3/4



TSI077

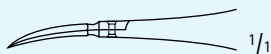

TSI077

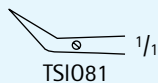
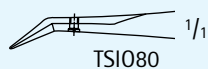
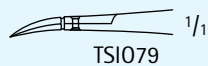
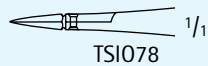

VANNAS Capsulotomy Scissors

Catalog Number	Tip	Blade	Handle	Length (in.)
TSIO78	S/S	STR	FLAT, SERR	3 1/4
TSIO79	S/S	CVD	FLAT, SERR	3 1/4
TSIO80	S/S	ANG-DOWN	FLAT, SERR	3 1/4
TSIO81	S/S	ANG-UP	FLAT, SERR	3 1/4

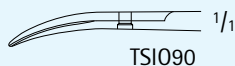
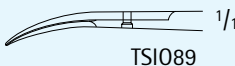
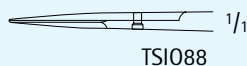
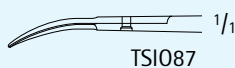
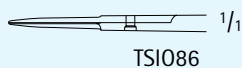
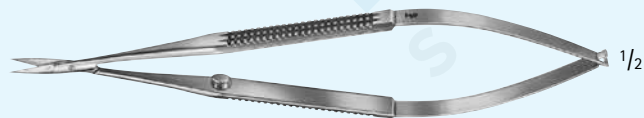
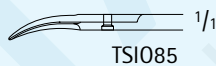
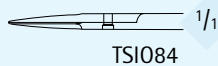
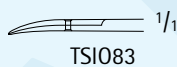
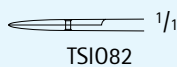

Micro Scissors

Catalog Number	Tip	Blade	Handle	Length (in.)
TSIO82	S/S	STR	FLAT, SERR	4 1/8
TSIO83	S/S	CVD	FLAT, SERR	4 1/8
TSIO84	S/S	STR	FLAT, SERR	4 3/4
TSIO85	S/S	CVD	FLAT, SERR	4 3/4
TSIO86	S/S	STR	FLAT, SERR	6 1/4
TSIO87	S/S	CVD	FLAT, SERR	6 1/4
TSIO88	S/S	STR	ROUND	5 3/4
TSIO89	S/S	CVD	ROUND	5 3/4
TSIO90	B/B	CVD	ROUND	5 3/4



TSI091

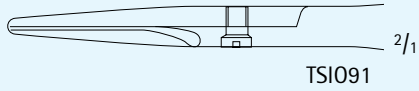

TSI091

MCCLURE Micro Scissors

Catalog Number	Tip	Blade	Handle	Length (in.)
TSI091	S/S	STR	FLAT, SERR	3 3/4



TSI092

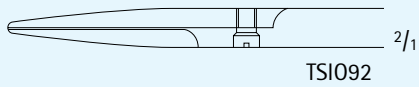

TSI092

NOYES Micro Scissors

Catalog Number	Tip	Blade	Handle	Length (in.)
TSI092	S/B	STR	FLAT, SERR	5



TSI093-TSI094

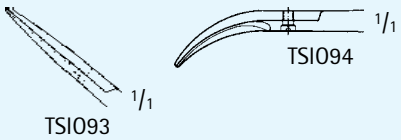

TSI093

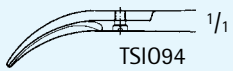

TSI094



TSI095-TSI096

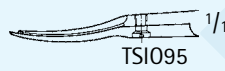

TSI095



TSI096

CASTROVIEJO Corneal Scissors

Catalog Number	Tip	Blade	Handle	Length (in.)
TSI093	B/B	LAT-ANG	FLAT, SERR	3 3/4
TSI094	B/B	LAT-CVD	FLAT, SERR	3 3/4
TSI095	B/B	LEFT-CVD	FLAT, SERR	4 3/8
TSI096	B/B	RIGHT-CVD	FLAT, SERR	4 3/8

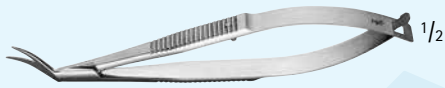

TSI097

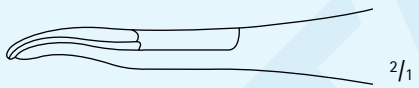

2/1



TSI097



TSI098



2/1



TSI098

CASTROVIEJO Corneal Section Scissors

Catalog Number	Tip	Tip Size (mm)	Blade	Handle	Length (in.)
TSI097	B/B	9	CVD, ANG RIGHT	FLAT, SERR	4 1/4
TSI098	B/B	9	CVD, ANG LEFT	FLAT, SERR	4 1/4



TSIO99

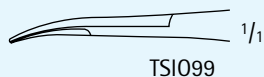

TSIO99

CASTROVIEJO Universal Corneal Scissors

Catalog Number	Tip	Tip Size	Blade	Handle	Length (in.)
TSIO99	B/B	16 MM FROM MID-SCREW	CVD	FLAT, FENESTRATED	4 3/4



TSIO100

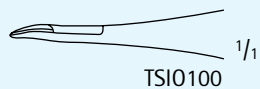

TSIO100



TSIO101



TSIO101

CASTROVIEJO Corneal Scissors

Catalog Number	Tip	Tip Size	Blade	Handle	Length (in.)
TSIO100	B/B	SMALL	CVD RIGHT	FLAT, WIDE SERR	4
TSIO101	B/B	SMALL	CVD LEFT	FLAT, WIDE SERR	4



TSIO102

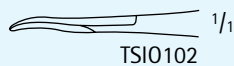

TSIO102



TSIO103

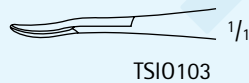

TSIO103

TROUTMAN-CASTROVIEJO Corneal Scissors, W/ Catch

Catalog Number	Tip	Tip Size	Blade	Handle	Length (in.)
TSIO102	B/B	MEDIUM	CVD RIGHT	FLAT, WIDE SERR	4 1/8
TSIO103	B/B	MEDIUM	CVD LEFT	FLAT, WIDE SERR	4 1/8



TSIO104

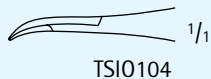

TSIO104

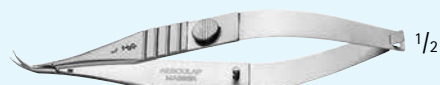

TSIO105

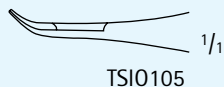

TSIO105

TROUTMAN-KATZIN Corneal Scissors, W/ Catch

Catalog Number	Tip	Blade	Handle	Length (in.)
TSIO104	B/B	STRONG CVD RIGHT	FLAT, WIDE SERR	4 1/8
TSIO105	B/B	STRONG CVD LEFT	FLAT, WIDE SERR	4 1/8



TSIO106



TSIO106

TROUTMAN Corneal Scissors, W/ Catch

Catalog Number	Tip	Blade	Handle	Length (in.)
TSIO106	B/B	CVD RIGHT	FLAT, WIDE SERR	4 1/8



TSIO107

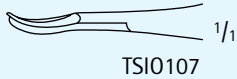

TSIO107

KATZIN Corneal Transplant Scissors

Catalog Number	Tip	Tip Size	Blade	Handle	Length (in.)
TSIO107	B/B	MEDIUM	CVD RIGHT	FLAT, FENESTRATED	4 1/8
TSIO108	B/B	MEDIUM	CVD LEFT	FLAT, FENESTRATED	4 1/8



TSIO108



TSIO108



TSIO109

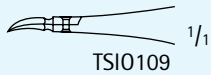

TSIO109

RICH Corneal Scissors

Catalog Number	Tip	Tip Size	Blade	Handle	Length (in.)
TSIO109	S/S	X-DEL	CVD RIGHT	FLAT, WIDE SERR	4 1/8
TSIO110	S/S	X-DEL	CVD LEFT	FLAT, WIDE SERR	4 1/8



TSIO110

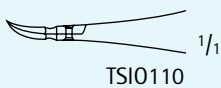

TSIO110



TSIO111

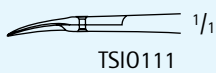

TSIO111

Micro Iris Scissors

Catalog Number	Tip	Tip Size	Blade	Handle	Length (in.)
TSIO111	S/S	10 MM FROM MID-SCREW	CVD	FLAT, SERR	4 1/8

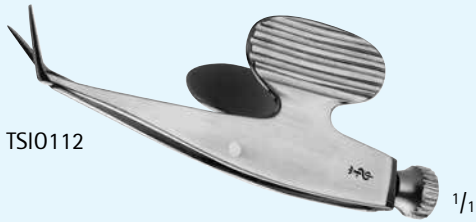

TSIO112

1/1



1/1

TSIO112

BARRAQUER Iris Scissors

Catalog Number	Tip	Tip Size (mm)	Blade	Length (in.)
TSIO112	B/B	8	ANG	2 1/4



TSIO113

1/2



1/1

TSIO113

JAFFE Stitch Scissors

Catalog Number	Tip	Blade	Handle	Length (in.)
TSIO113	X-SHARP/ X-SHARP	CVD	FLAT, WIDE SERR	4 3/4



TSIO114

1/2

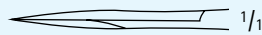

1/1

TSIO114

Stitch Scissors, Fine

Catalog Number	Tip	Blade	Handle	Length (in.)
TSIO114	S/S	STR	FLAT, WIDE SERR	5 1/8



TSIO115

1/2

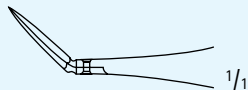

1/1

TSIO115

STERN-GILLS Scissors

Catalog Number	Tip	Tip Size (mm)	Blade	Handle	Length (in.)
TSIO115	S/S	10	STR-ANG FORWARD	FLAT, WIDE SERR	4 1/2



TSIO116

1/2

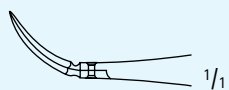

1/1

TSIO116

URIBE-STERN Scissors

Catalog Number	Tip	Tip Size (mm)	Blade	Handle	Length (in.)
TSIO116	S/S	10	CVD-ANG FORWARD	FLAT, WIDE SERR	4 3/4



TSIO117

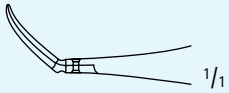

TSIO117

UTHOFF-GILLS Capsulotomy Scissors

Catalog Number	Tip	Tip Size (mm)	Blade	Handle	Length (in.)
TSIO117	B/B	10	ANG, CVD	FLAT, WIDE SERR	4 3/4



TSIO118

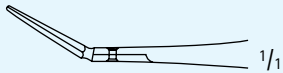

TSIO118

GILLS-WELSH VANNAS Scissors

Catalog Number	Tip	Tip Size (mm)	Handle	Length (in.)
TSIO118	S/S	11	FLAT, WIDE SERR	3 1/4



TSIO119

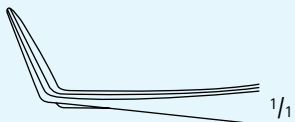

TSIO119

DEWECKER Iris Scissors

Catalog Number	Tip	Blade	Length (in.)
TSIO119	S/B	CVD	4 1/2

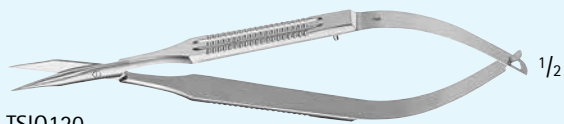

TSIO120

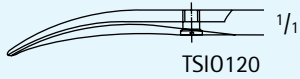

TSIO120

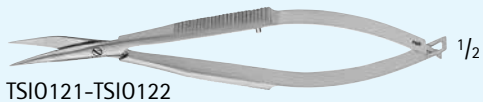

TSIO121-TSIO122

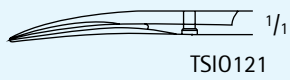

TSIO121

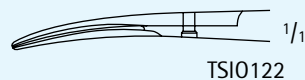

TSIO122

WESTCOTT Stitch and Utility Scissors

Catalog Number	Tip	Blade	Handle	Length (in.)
TSIO120	S/S	CVD	FLAT, SERR	5 1/2
TSIO121	S/S	CVD	FLAT, SERR	4 1/2
TSIO122	B/B	CVD	FLAT, SERR	4 1/2

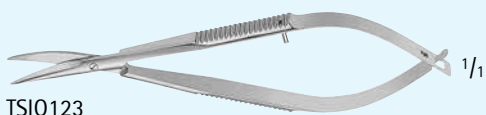

TSIO123

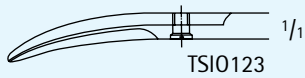

TSIO123

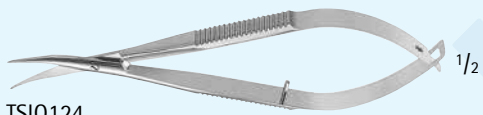

TSIO124

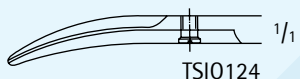

TSIO124

WESTCOTT Tenotomy Scissors

Catalog Number	Tip	Blade	Handle	Length (in.)
TSIO123	B/B	CVD, RIGHT HAND	FLAT, SERR	4 3/4
TSIO124	B/B	CVD, LEFT HAND	FLAT, SERR	4 3/4



TSIO125-TSIO126

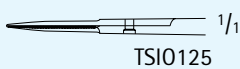

TSIO125

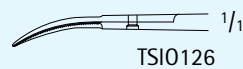

TSIO126

MILLESI Micro Scissors

Catalog Number	Tip	Blade	Handle	Length (in.)
TSIO125	S/S	STR, SERR	FLAT, SERR	6 1/4
TSIO126	S/S	CVD, SERR	FLAT, SERR	6 1/4

BARRAQUER Micro Needle Holder,
Round Knurled Handle W/O Catch

Catalog Number	Tip	Length (in.)
TSIO127	STR	4 3/4
TSIO128	STR	5 1/4
TSIO129	CVD, DEL	4 3/4
TSIO130	CVD	4 1/4
TSIO131	CVD	4 1/2
TSIO132	CVD	4 3/4
TSIO133	CVD	5 1/4

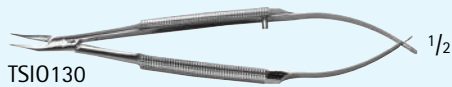

TSIO130



TSIO130

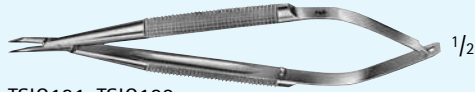

TSIO131, TSIO129

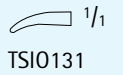

TSIO131

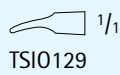

TSIO129



TSIO127-TSIO132

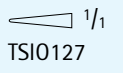

TSIO127

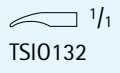

TSIO132

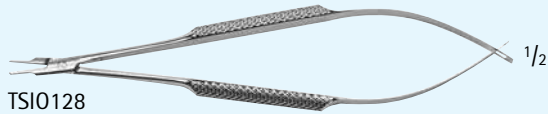

TSIO128

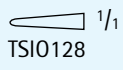

TSIO128

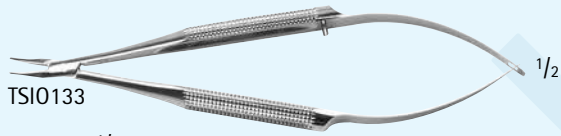

TSIO133

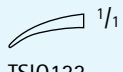

TSIO133



TSIO134-TSIO136

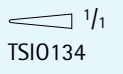

TSIO134

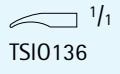

TSIO136

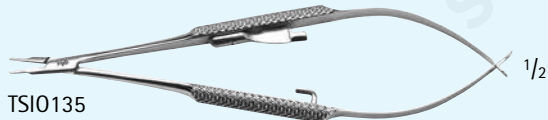

TSIO135

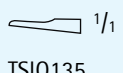

TSIO135

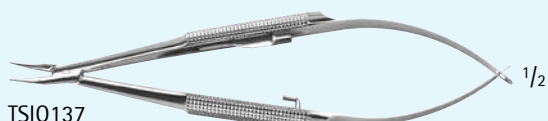

TSIO137



TSIO137

BARRAQUER Micro Needle Holder,
Round Knurled Handle W/ Catch

Catalog Number	Tip	Length (in.)
TSIO134	STR	4 3/4
TSIO135	STR	5 1/4
TSIO136	CVD	4 3/4
TSIO137	CVD	5 1/4



TSIO138

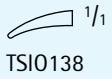

TSIO138



TSIO139

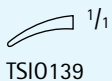

TSIO139

COHEN Micro Needle Holder, Round Knurled Handle

Catalog Number	Tip	Handle	Length (in.)
TSIO138	CVD	W/O CATCH	4 1/8
TSIO139	CVD	W/ CATCH	4 1/8

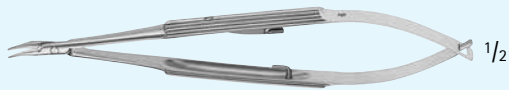

TSIO140-TSIO141

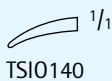

TSIO140

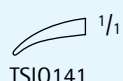

TSIO141

TROUTMAN Micro Needle Holder, Flat Handle W/ Catch

Catalog Number	Tip	Length (in.)
TSIO140	CVD	4 3/4
TSIO141	CVD	5 1/8

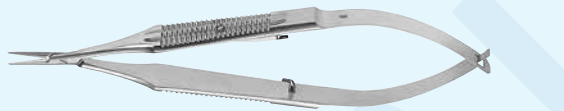

TSIO142-TSIO144, TSIO143

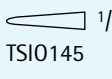

TSIO145

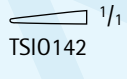

TSIO142

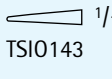

TSIO143

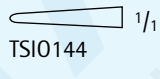

TSIO144

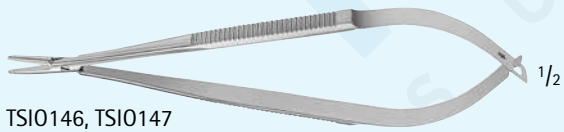

TSIO146, TSIO147

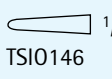

TSIO146



TSIO147

CASTROVIEJO Micro Needle Holder, Flat Handle

Catalog Number	Tip	Jaw Length (mm)	Handle	Length (in.)
TSIO142	STR	9	W/ CATCH	5 1/2
TSIO143	STR	9	W/ CATCH	5 1/8
TSIO144	STR	16	W/ CATCH	5 7/8
TSIO145	STR	10	W/ CATCH	5 3/8
TSIO146	STR	10	W/O CATCH	5 3/8
TSIO147	CVD	10	W/O CATCH	5 3/8

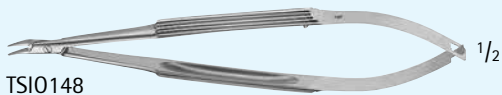

TSIO148

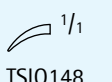

TSIO148

Micro Needle Holder, Round Knurled Handle W/O Catch

Catalog Number	Tip	Length (in.)
TSIO148	DEL, CVD	4 3/4

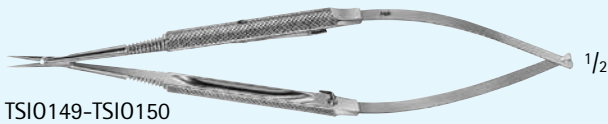

TSIO149-TSIO150

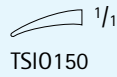
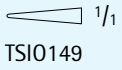

Micro Needle Holder, Round Knurled Handle W/ Catch

Catalog Number	Tip	Length (in.)
TSIO149	STR	6
TSIO150	CVD	6



TSIO151



HAMPTON Micro Needle Holder, Heavy Jaw, Round Knurled Handle W/ Catch

Catalog Number	Tip	Length (in.)
TSIO151	CVD	5 1/8



TSIO152, TSIO154

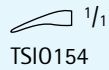
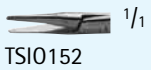

TSIO153-TSIO155

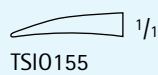
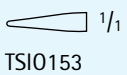

MCPHERSON Micro Needle Holder, Flat Handle, Delicate

Catalog Number	Tip	Handle	Length (in.)
TSIO152	STR	SERR W/ CATCH	4 1/4
TSIO153	STR	FENESTRATED W/O CATCH	4 1/4
TSIO154	CVD	SERR W/O CATCH	4 1/8
TSIO155	CVD	FENESTRATED W/ CATCH	4 1/8



TSIO156

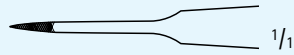

TSIO156



TSIO157

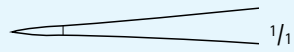

TSIO157



TSIO158



TSIO158



TSIO159



TSIO159



TSIO160

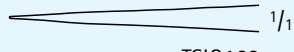

TSIO160



TSIO161

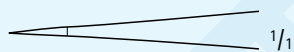

TSIO161



TSIO162

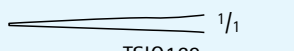

TSIO162

Micro Jewelers Forceps

Catalog Number	Tip	Tip Size (mm)	Tip Size (#)	Length (in.)
TSIO156	STR, W/ PLATFORM, X-SERR	3	-	4 1/4
TSIO157	STR, FINE, W/ PLATFORM	6	1	4 3/4
TSIO158	STR, FINE	-	1	4 3/4
TSIO159	STR, X-FINE, W/ PLATFORM	5	3	4 3/8
TSIO160	STR	0.3	3	5 1/4
TSIO161	STR, X-FINE, W/ PLATFORM	5	3	4 3/4
TSIO162	STR, X-FINE, W/ PLATFORM	6	4	4 3/8
TSIO163	STR	0.2	4	4 1/4
TSIO164	STR, X-FINE, W/ PLATFORM	6	5	4 3/8
TSIO165	STR	0.15	5	4 1/4
TSIO166	CVD	0.20	5	4 1/2



TSIO163



TSIO163



TSIO164

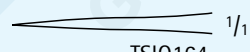

TSIO164



TSIO165



TSIO165



TSIO166



TSIO166

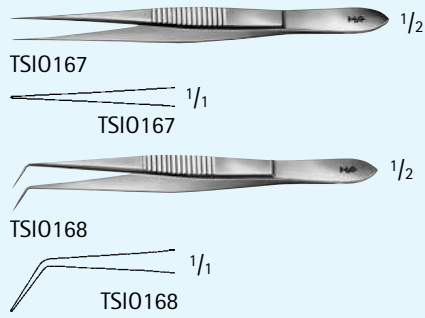

Micro Forceps

Catalog Number	Tip	Jaw	Length (in.)
TSIO167	STR	SMOOTH	4
TSIO168	ANG	SMOOTH	4

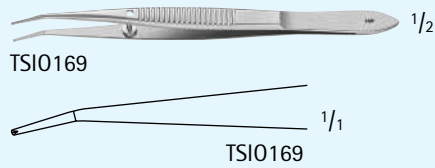

BARRAQUER Cilia Forceps

Catalog Number	Tip	Tip Size (mm)	Length (in.)
TSIO169	SLIGHT-ANG	6	4 1/9

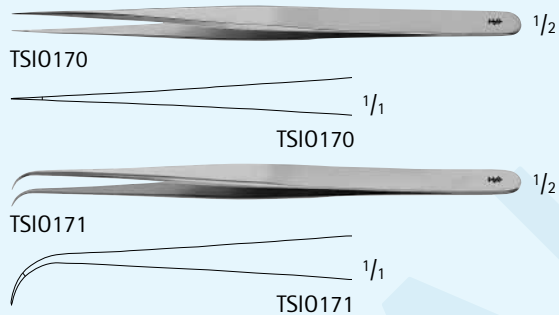

WISE Micro Suture Forceps W/ Platform

Catalog Number	Tip	Tip Size (mm)	Length (in.)
TSIO170	STR	0.3	5 1/4
TSIO171	CVD	0.3	5 1/4

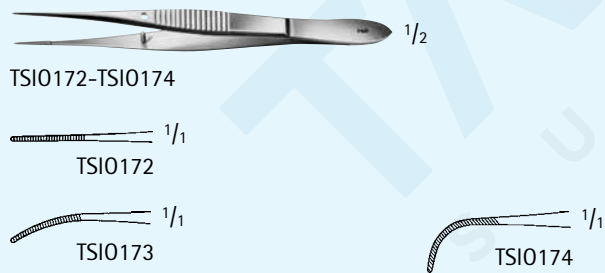

Iris Forceps, Delicate

Catalog Number	Tip	Jaw	Length (in.)
TSIO172	STR	SERR	4
TSIO173	CVD	SERR	4
TSIO174	HEAVY-CVD	SERR	4

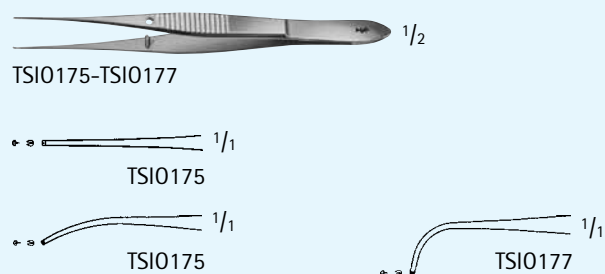

Iris Forceps, X-Fine

Catalog Number	Tip	Teeth	Length (in.)
TSIO175	STR	1 x 2	4
TSIO176	CVD	1 x 2	4
TSIO177	HEAVY-CVD	1 x 2	4



TSIO178

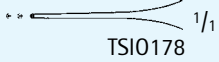

TSIO179



BISHOP-HARMON Iris Forceps

Catalog Number	Teeth	Jaw	Length (in.)
TSIO178	1 x 2	-	3 1/4
TSIO179	-	SERR	3 1/2



TSIO180

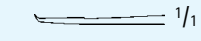
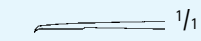
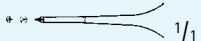

TSIO180

ST. MARTIN Tissue Forceps, Delicate

Catalog Number	Teeth	Length (in.)
TSIO180	1 x 2	3 1/8



TSIO181

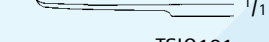
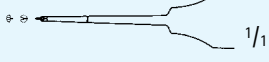

TSIO181

CASTROVIEJO Tissue Forceps, Delicate

Catalog Number	Tip Size (mm)	Teeth	Length (in.)
TSIO181	0.9	1 x 2	4

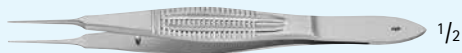

TSIO182

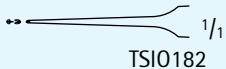

TSIO182

CASTROVIEJO Fixation Forceps, W/O Platform

Catalog Number	Tip Size (mm)	Teeth	Length (in.)
TSIO182	0.5	1 x 2	4 1/4

CASTROVIEJO Suture Forceps,
W/ 1 x 2 Teeth

Catalog Number	Tip	Tip Size (mm)	Platform	Handle	Length (in.)
TSIO182	STR	0.12	YES	SERR	4 1/8
TSIO183	STR	0.12	YES	SERR	4 3/8
TSIO184	STR	0.22	YES	SERR	4 1/4
TSIO185	STR	0.3	YES	SERR	4 1/8
TSIO186	STR	0.3	YES	SERR	4 3/8
TSIO187	STR	0.5	YES	WIDE	4 1/4
TSIO188	STR	0.5	YES	SERR	4 1/4
TSIO189	STR	0.5	NO	WIDE W/ LOCK	4 1/4
TSIO190	STR	0.9	YES	SERR	4 1/4
TSIO191	STR	1.5	YES	WIDE	4 1/4
TSIO192	ANG 45°	0.5	YES	SERR	4 1/4

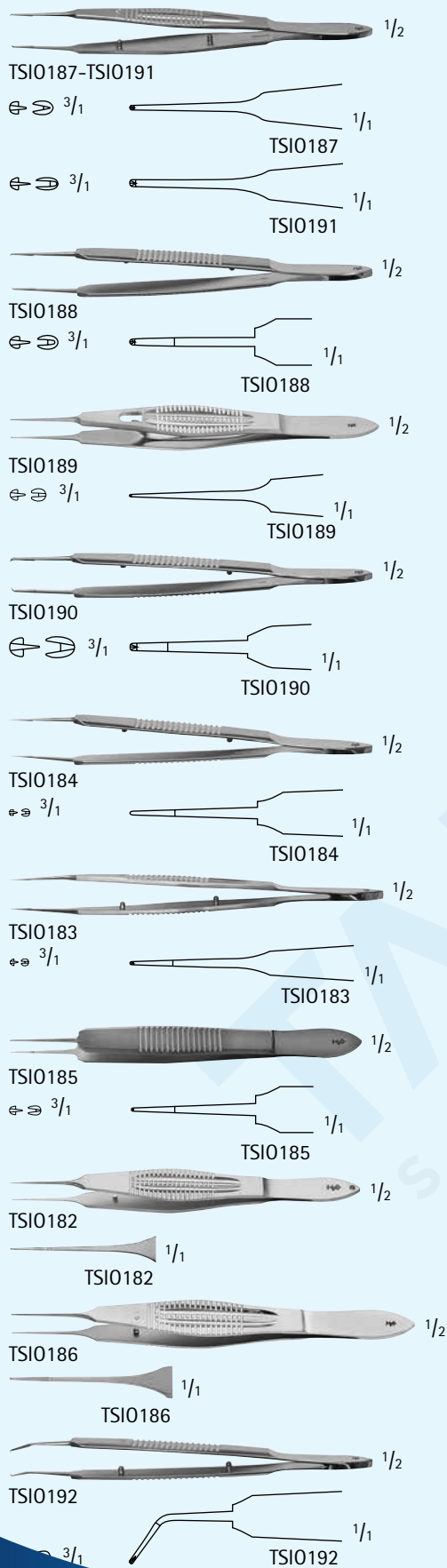

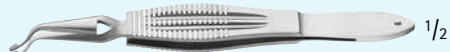

TSI0193



CASTROVIEJO Capsule Forceps,
Cross-Action

Catalog Number	Tip	Length (in.)
TSI0193	10 MM FROM ANGLE TO TIP	4 1/8

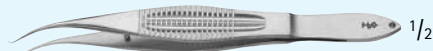

TSI0194



CASTROVIEJO Colibri Type Corneal
Forceps

Catalog Number	Tip Size (mm)	Teeth	Length (in.)
TSI0194	0.12	1 x 2	4 1/8



TSI0195

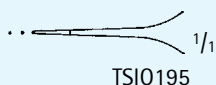

BONN Eye Forceps, W/ Platform

Catalog Number	Tip Size (mm)	Teeth	Length (in.)
TSI0195	0.2	1 x 2	3 3/4



TSI0196

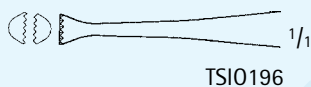

GRAEFE Tissue Forceps

Catalog Number	Length (in.)
TSI0196	4 1/4



TSI0197-TSI0198

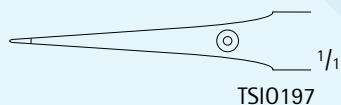

TSI0197

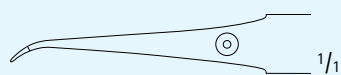

TSI0198

Suture Tying Forceps, W/ Platform

Catalog Number	Tip	Tip Size (mm)	Length (in.)
TSI0197	STR	0.3	4 3/4
TSI0198	CVD	0.3	4 3/4

Type your text



TSI0199

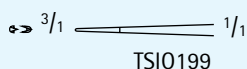

OSHER-ELSCHNIG Forceps,
W/ Platform

Catalog Number	Tip	Tip Size (mm)	Teeth	Length (in.)
TSI0199	Q.12	3	1 x 2	4 1/8



TSIO200-TSIO201

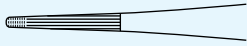

TSIO200-TSIO201

BONACCOLTO Utility Forceps

Catalog Number	Tip Size (mm)	Length (in.)
TSIO200	1.2 x 16	4 1/4
TSIO201	1.7 x 17	4 1/4



TSIO202

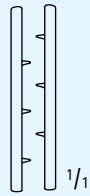
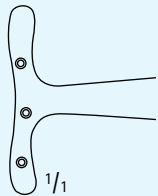

TSIO202

PUTTERMAN-Type Muscle Forceps, W/ Lock

Catalog Number	Tip	Jaw	Length (in.)
TSIO202	6 PINS	SERR	4



TSIO203

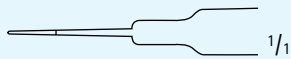

TSIO203

TENNANT Tying Forceps, W/ Platform

Catalog Number	Tip	Tip Size (mm)	Jaw	Handle	Length (in.)
TSIO203	X-DEL	6	SMOOTH	ROUND	4 1/4



TSIO204

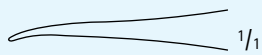

TSIO204

SINSKEY Tying Forceps

Catalog Number	Tip	Jaw	Handle	Length (in.)
TSIO204	X-DEL	SMOOTH, CVD	FLAT, WIDE SERR	4

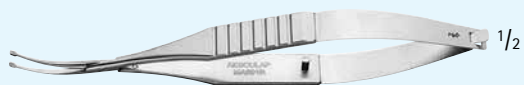

TSIO205

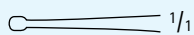

TSIO205



SHEPARD Lens Holding Forceps, Cross-Action

Catalog Number	Tip	Jaw	Handle	Length (in.)
TSIO205	DUCKBILL	CVD	FLAT, WIDE SERR	5



TSIO206

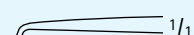

TSIO206



CLAYMAN Lens Holding Forceps, Cross-Action

Catalog Number	Tip	Jaw	Handle	Length (in.)
TSIO206	DEL, ANG	CVD	FLAT, WIDE SERR	4 3/4



TSIO207

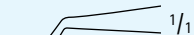

TSIO207



1/1

Scleral Plug Forceps, Cross-Action

Catalog Number	Tip	Tip Size (mm)	Jaw	Handle	Length (in.)
TSIO207	DVD	9	ANG	FLAT, SERR	4 1/8



TSIO208



TSIO208

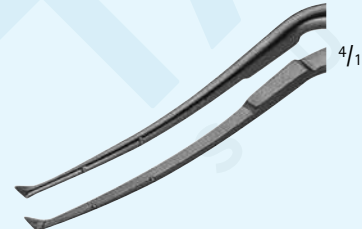

DEVGAN Titanium Capsulorhexis Forceps, Cross-Action

Catalog Number	Tip	Handle	Length (in.)
TSIO208	X-DEL, SEMI-SHARP	ROUND	5



TSIO209



TSIO209

GRIFFITHS-BROWN Tissue Forceps

Catalog Number	Tip	Length (in.)
TSIO209	DEL	4 1/4

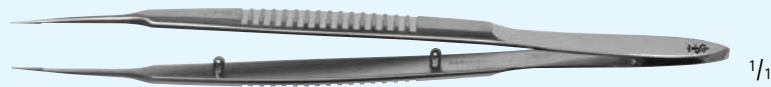

TSIO210

1/1

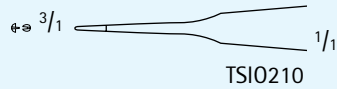

BONN Suture Forceps, W/ Platform

Catalog Number	Tip Size (mm)	Teeth	Length (in.)
TSIO210	0.12	1 x 2	3 3/4



TSIO211

1/1

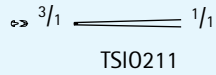

BONN Tissue Forceps

Catalog Number	Tip Size (mm)	Teeth	Length (in.)
TSIO211	0.12	1 x 2	3 3/4

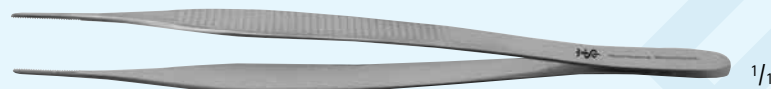

TSIO212

1/1

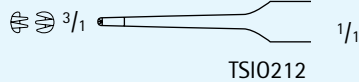

THORPE Conjunctival Fixation Forceps, W/ Platform

Catalog Number	Teeth	Length (in.)
TSIO212	2 x 3	3 3/4



TSIO213

1/1

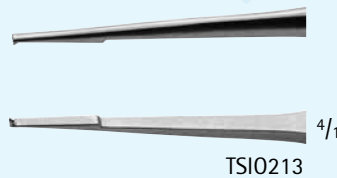

THORPE Corneal Forceps W/ Platform

Catalog Number	Tip Size (mm)	Jaw	Teeth	Length (in.)
TSIO213	0.12	STR	2 x 3, ANG 45°	3 3/4



TSIO214-TSIO215

1/1

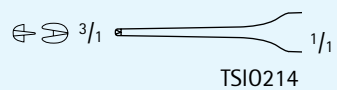

TSIO214

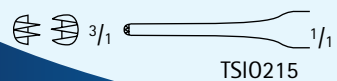

TSIO215

LESTER Fixation Forceps

Catalog Number	Teeth	Length (in.)
TSIO214	FINE, 1 x 2	3 3/4
TSIO215	FINE, 2 x 3	3 3/4



TSIO216-TSIO217

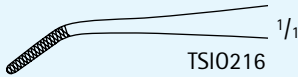

TSIO216

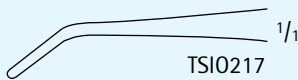

TSIO217

NUGENT Utility Forceps

Catalog Number	Jaw	Jaw Length (mm)	Length (in.)
TSIO216	SERR, ANG 45°	10	4 1/4
TSIO217	SMOOTH, ANG 45°	10	4 1/4



TSIO218

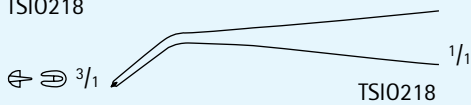

TSIO218

TROUTMAN Superior Rectus Forceps

Catalog Number	Tip Size (mm)	Jaw	Teeth	Length (in.)
TSIO218	10	ANG	1 x 2	4 1/8



TSIO219-TSIO220



TSIO219-TSIO220

BERKE Ptosis Forceps, W/ Lock

Catalog Number	Jaw Length (mm)	Length (in.)
TSIO219	20	4
TSIO220	27	4 1/8



TSIO221

Serrefine Clamp

Catalog Number	Tip	Jaw	Jaw Length (mm)	Length (in.)
TSIO221	STR	SERR	10	1 3/8



TSIO222

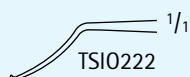

TSIO222



TSIO222

LEHNER-UTRATA Capsulotomy Forceps

Catalog Number	Tip	Tip Size (mm)	Length (in.)
TSIO222	ANG	12	3 1/2

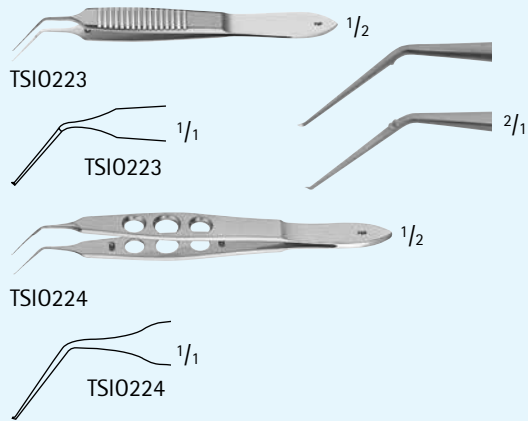

UTRATA Capsulorhexis Forceps

Catalog Number	Tip	Tip Size (mm)	Handle	Length (in.)
TSIO223	ANG	12	FLAT, SERR	3 1/8
TSIO224	ANG	11	FLAT, FENESTRATED	4

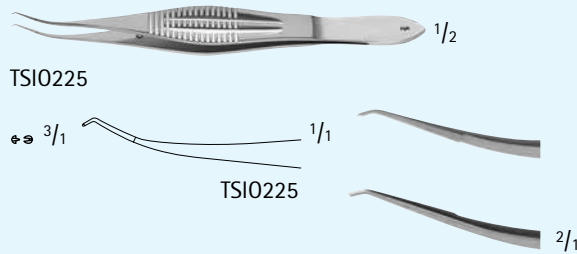

COLIBRI-Style Corneal Forceps, W/ Platform

Catalog Number	Tip	Tip Size (mm)	Teeth	Length (in.)
TSIO225	ANG 60°	1 x 2		4 1/4

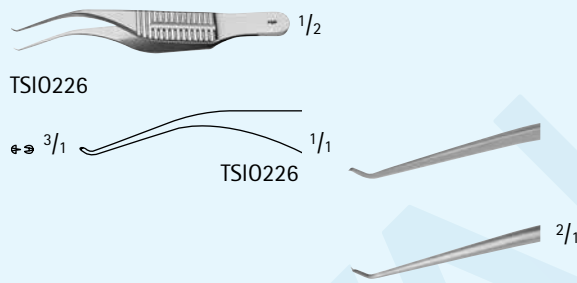

TROUTMAN-BARRAQUER Corneal Forceps

Catalog Number	Tip Size (mm)	Teeth	Length (in.)
TSIO226	0.12	1 x 2	2 7/8

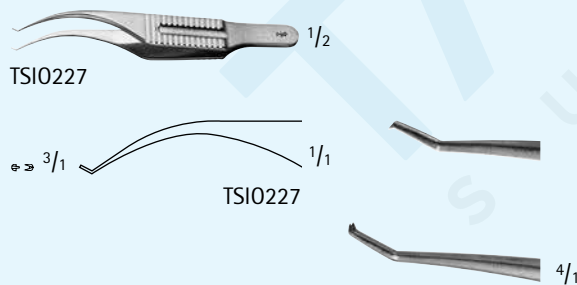

Titanium COLIBRI Forceps

Catalog Number	Tip Size (mm)	Jaw	Teeth	Length (in.)
TSIO227	0.12	SMOOTH	1 x 2	3

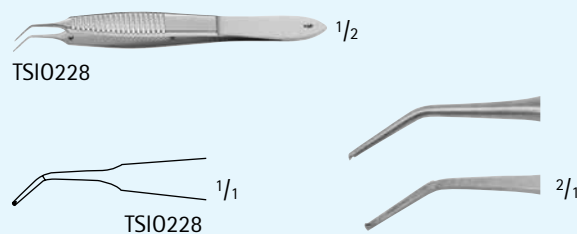

MCPHERSON Angled Corneal Suturing Forceps, W/ Platform

Catalog Number	Tip	Tip Size (mm)	Teeth	Length (in.)
TSIO228	ANG 45°	1 x 2		3 3/8

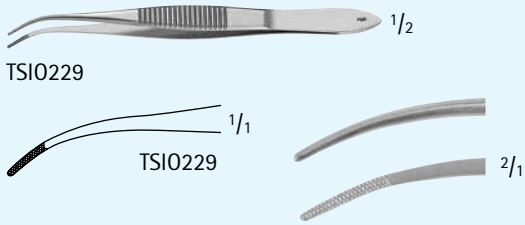

BRACKEN Iris Forceps

Catalog Number	Tip	Jaw	Length (in.)
TSIO229	CVD	CROSS-SERR	3 7/8

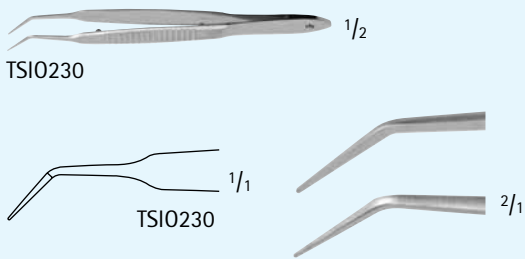

**KELMAN-MCPHERSON Forceps,
W/ Platform**

Catalog Number	Tip	Tip Size (mm)	Length (in.)
TSIO230	ANG 45°	8.5	3 3/8

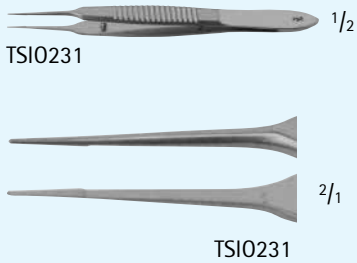

MCPHERSON Forceps, W/ Platform

Catalog Number	Tip	Tip Size (mm)	Length (in.)
TSIO231	STR	5	3 1/4

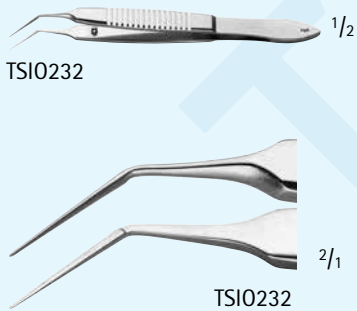

BECHERT-MCPHERSON Forceps

Catalog Number	Tip	Tip Size (mm)	Jaw	Length (in.)
TSIO232	ANG	10	SMOOTH	3 1/4

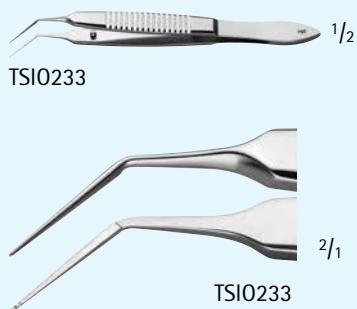

SHEETS-MCPHERSON Forceps

Catalog Number	Tip	Tip Size (mm)	Jaw	Length (in.)
TSIO233	1 MM X-SERR	10	ANG	3 1/4



TSIO234

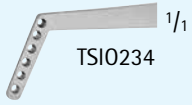

TSIO234



TSIO235

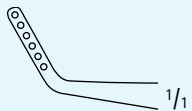

TSIO235

JAMESON Muscle Forceps, W/ Lock

Catalog Number	Tip Size (mm)	Jaw	Length (in.)
TSIO234	12	ANG, LEFT	3 3/8
TSIO235	12	ANG, RIGHT	4



TSIO236

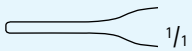

TSIO236

MCCULLOUGH Utility Forceps

Catalog Number	Tip	Tip Size (mm)	Jaw	Length (in.)
TSIO236	STR	15	SMOOTH	3 5/8



TSIO237

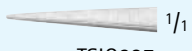

TSIO237

Tying Forceps

Catalog Number	Jaw	Handle	Length (in.)
TSIO237	SMOOTH	FLAT, SERR	4 1/4



TSIO238



TSIO238

Alabama University Forceps,
W/ Platform

Catalog Number	Tip	Tip Size (mm)	Length (in.)
TSIO238	V-GROOVED	15	3 1/2



TSIO239

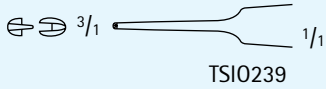

TSIO239

Von GRAEFE Iris Forceps

Catalog Number	Tip	Teeth	Length (in.)
TSIO239	STR	1 x 2	3



TSIO240

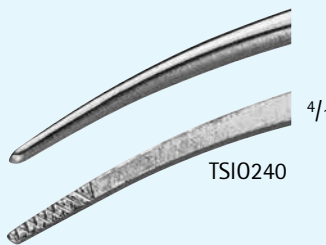

TSIO240

GILL Iris Forceps

Catalog Number	Tip	Jaw	Length (in.)
TSIO240	CVD	CROSS-SERR	3



TSIO241



TSIO241

WILLS Hospital Utility Forceps

Catalog Number	Tip	Jaw	Length (in.)
TSIO241	STR	SERR	4

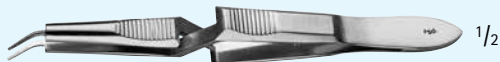

TSIO242

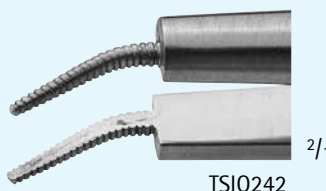

TSIO242

WATZKE Sleeve Spreading Forceps

Catalog Number	Tip	Jaw Length (mm)	Length (in.)
TSIO242	ANG	10	4 3/4

BARRAQUER Eye Speculum

Catalog Number	Blade Size (mm)	Frame	Length (in.)
TSIO243	10	WIRE	1 1/2
TSIO244	10	WIRE	1 3/4
TSIO245	14	HEAVY WIRE	1 3/4
TSIO246	15	SOLID	1 3/4

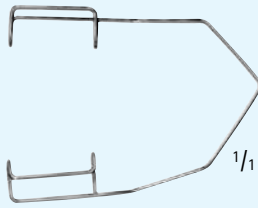

TSIO243

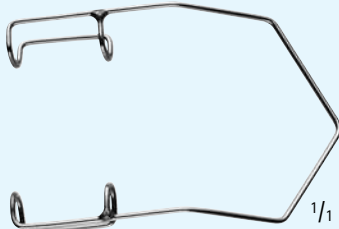

TSIO244

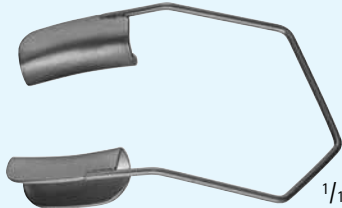

TSIO245

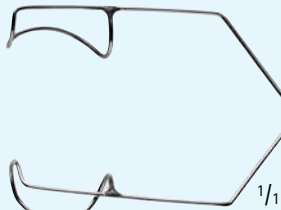

TSIO246

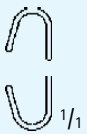

KRATZ-BARRAQUER Eye Speculum

Catalog Number	Blade Size (mm)	Blade Shape	Length (in.)
TSIO247	10	PEDIATRIC	1 3/8
TSIO248	14	ADULT	1 1/2

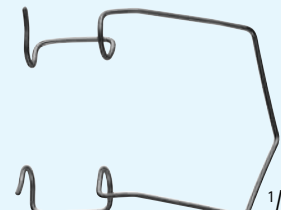

TSIO247

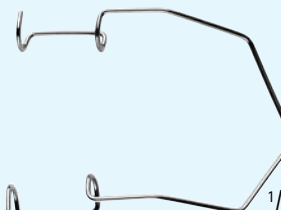

TSIO248



TSIO249

ALPHONSO Speculum, Infant

Catalog Number	Blade Size (mm)	Length (in.)
TSIO249	7 x 5 AND 9 WIDE	1 3/4



TSIO250

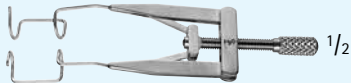

TSIO251

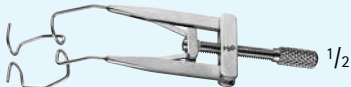

TSIO252

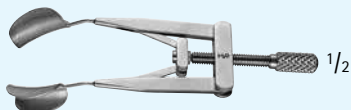

TSIO253



TSIO254

LIEBERMAN Speculum, Adjustable

Catalog Number	Blade Size (mm)	Blade Shape	Length (in.)
TSIO250	16	STR, SQUARE WIRE	3 1/8
TSIO251	14	ANG, SQUARE WIRE	3 1/4
TSIO252	14	ANG, V-SHAPE WIRE	3 1/4
TSIO253	14	ANG, SOLID	3 1/4
TSIO254	14	ANG, REVERSIBLE, SOLID	3 1/8



TSIO255



TSIO256

JAFFE Wire Lid Retractor, Pair

Catalog Number	Blade Size (mm)	Length (in.)
TSIO255	13	1 1/2
TSIO256	15	1 1/2



TSI0257



TSI0257

SAUER Eye Speculum

Catalog Number	Length (in.)
TSI0257	1 3/8



TSI0258



TSI0258

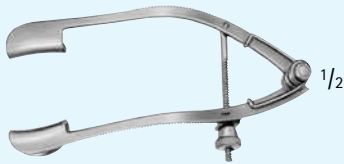

TSI0259



TSI0259

LANCASTER Eye Speculum

Catalog Number	Length (in.)
TSI0258	2 3/4
TSI0259	3 1/8

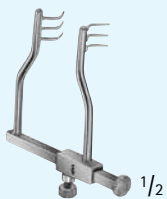

TSI0260



TSI0260

LOGAN Modified REILL Self-Retaining Retractor

Catalog Number	Length (in.)
TSI0260	2



TSIO261-TSIO264

SEWALL Orbital Retractor

Catalog Number	Blade Size (mm)	Length (in.)
TSIO261	7 x 52	6 3/4
TSIO262	9 x 44	6 3/8
TSIO263	11 x 50	6 3/8
TSIO264	13 x 67	6 3/4

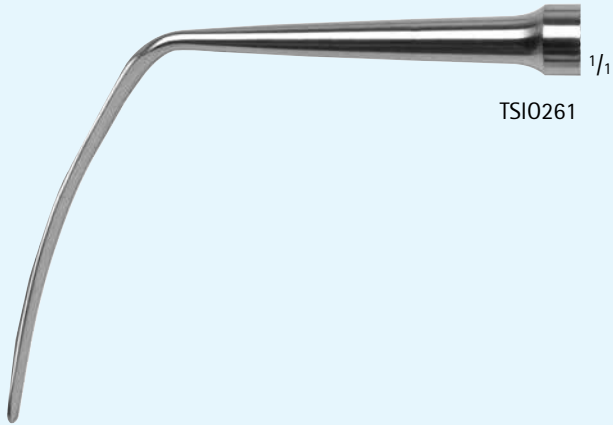

TSIO261



TSIO262

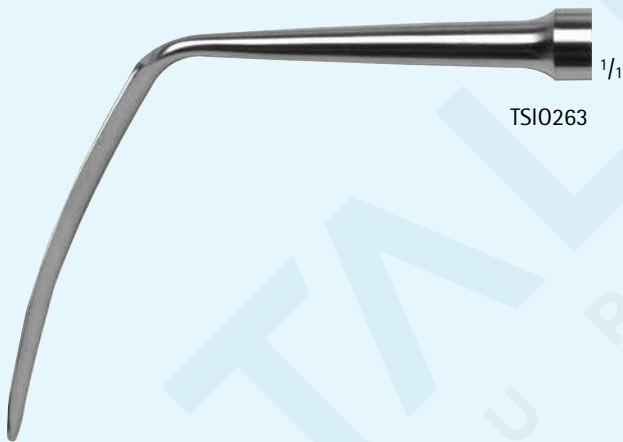

TSIO263



TSIO264



TSIO265-TSIO269

DESMARRES Lid Retractor

Catalog Number	Blade Size (mm)	Length (in.)
TSIO265	9 x 9	5 1/2
TSIO266	9 x 12	5 1/2
TSIO267	11 x 14	5 1/2
TSIO268	12 x 16	5 1/2
TSIO269	13 x 18	5 1/2

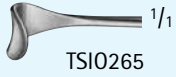

TSIO265

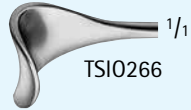

TSIO266

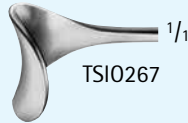

TSIO267



TSIO268



TSIO269



TSIO270

SCHEPENS Orbital Retractor

Catalog Number	Tip	Blade Size (mm)	Length (in.)
TSIO270	SMOOTH	14 x 61	6 1/8



TSIO271

JAEGER Lid Plate, Clear Plastic

Catalog Number	Blade Size (mm)	Length (in.)
TSIO271	20/23	3 3/4



TSIO272

BERKE-JAEGER Lid Plate

Catalog Number	Blade Size (mm)	Length (in.)
TSIO272	20/30	4 1/4



TSIO273

WELLS Enucleation Spoon

Catalog Number	Diameter (mm)	Length (in.)
TSIO273	21	5 3/4



TSIO274-TSIO275



TSIO274



TSIO275

BUNGE Evisceration Spoon

Catalog Number	Tip	Diameter (mm)	Length (in.)
TSIO274	SMALL	8	5 1/4
TSIO275	LARGE	12	5 1/2



TSIO276



TSIO276

SCHOCKET Scleral Depressor, Double Ended

Catalog Number	Length (in.)
TSIO276	5 1/4



TSIO277



TSIO277

FLYNN Scleral Depressor

Catalog Number	Diameter (mm)	Length (in.)
TSIO277	5	3 1/8

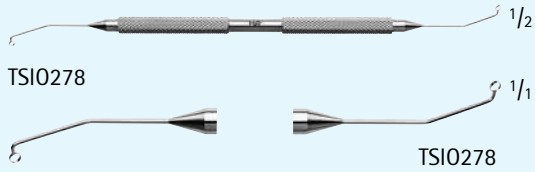

WHITMAN-SHEPHERD Capsule Polisher, Double Ended

Catalog Number	Tip	Length (in.)
TSIO278	LEFT ANG, RIGHT ANG	5 1/8

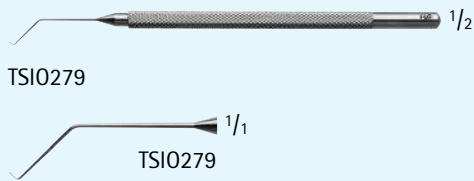

KOCH Stop and Chop Manipulator, Angled Shaft

Catalog Number	Tip Size (mm)	Length (in.)
TSIO279	1.5	4 3/4

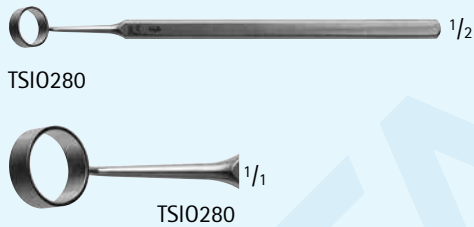

CAMELLIN Style LASIK Alcohol Well

Catalog Number	Diameter (mm)	Length (in.)
TSIO280	8.5	4 1/2

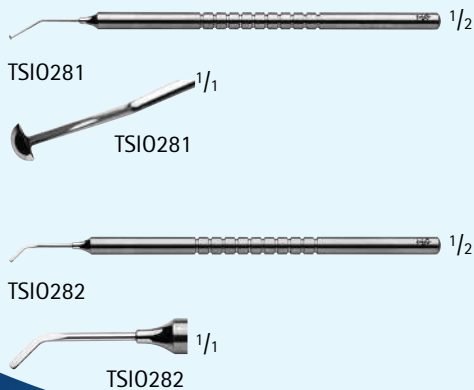

SLOANE LASIK Spatula

Catalog Number	Tip	Description	Length (in.)
TSIO281	SEMI-CIRCULAR, BEVELED EDGE	MICRO HOE	4 1/2
TSIO282	SEMI-SHARP	EPI PEELER	4 1/2

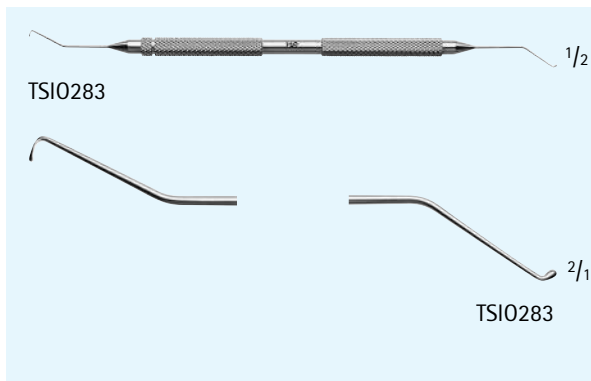

CHANG-SEIBEL Phaco Chopper, Double Ended

Catalog Number	Tip	Style	Length (in.)
TSIO283	ANG C-SHAPED BLUNT CHOPPER / VERTICAL SAFETY CHOPPER	F/ LEFT HAND	5 1/2

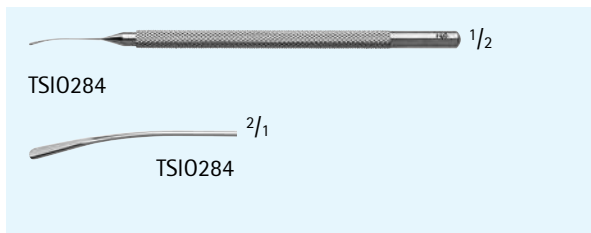

KOCH Nucleus Spatula

Catalog Number	Tip	Tip Size (mm)	Length (in.)
TSIO284	SLIGHTLY CVD W/ DUCKBILL TIP	1	4 1/2

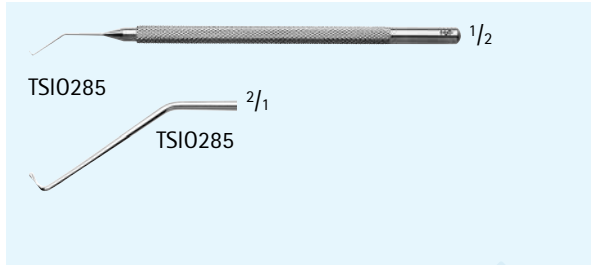

LIEBERMAN Nucleus Manipulator

Catalog Number	Style	Shaft	Length (in.)
TSIO285	F/ LEFT HAND	ANG	4 1/2

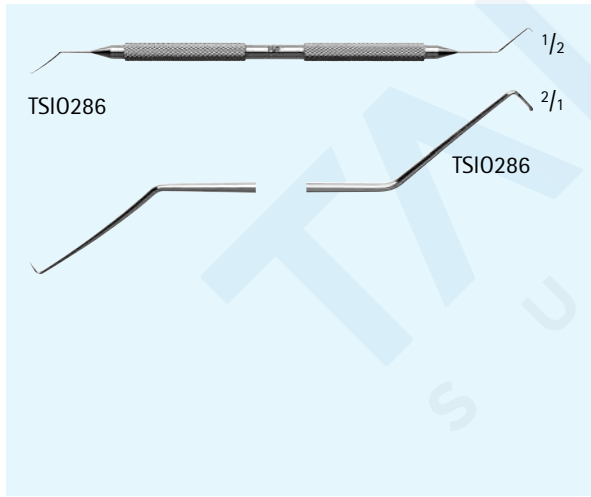

CHANG Combo Phaco Chopper, Double Ended

Catalog Number	Tip	Style	Shaft	Length (in.)
TSIO286	C-SHAPED BLUNT CHOPPER / 1.3 MM SHARP QUICK CHOP TIP	F/ LEFT HAND	ANG	5 1/4

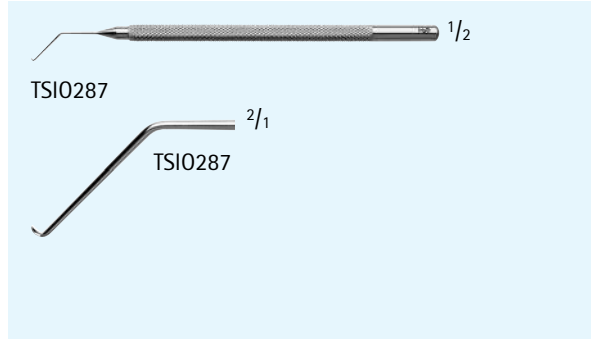

NAGAHARA Nucleus Spatula

Catalog Number	Tip	Style	Shaft	Length (in.)
TSIO287	FLAT INTERIOR EDGE	F/ LEFT HAND	ANG	4 1/4

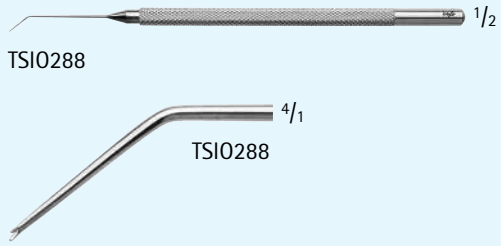

BECHERT Nucleus Rotator

Catalog Number	Tip	Shaft	Length (in.)
TSIO288	Y-SHAPED	ANG 45° 7 MM FROM TIP	4 3/4

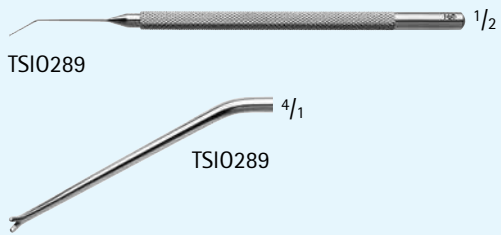

JAFFE-BECHERT Nucleus Rotator

Catalog Number	Tip	Shaft	Length (in.)
TSIO289	Y-SHAPED	ANG 45° 9 MM FROM TIP	4 3/4

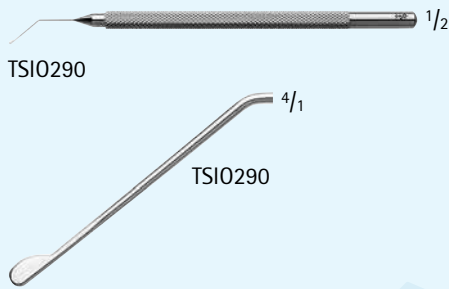

DRYSDALE Nucleus Manipulator

Catalog Number	Tip	Length (in.)
TSIO290	PADDLE-SHAPED	4 1/4

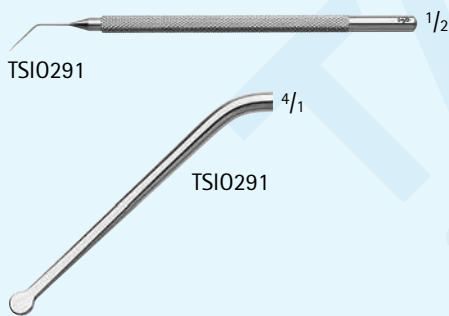

PISACANO Nucleus Rotator

Catalog Number	Tip	Length (in.)
TSIO291	VERTICAL FLAT	4 1/4

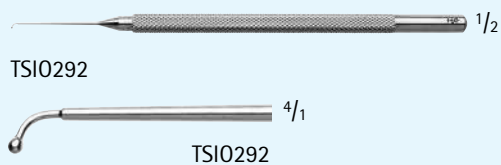

ANIS-WAND Nucleus Manipulator

Catalog Number	Tip	Tip Size (mm)	Shaft	Length (in.)
TSIO292	BALL-SHAPED	0.5	STR	4 3/4

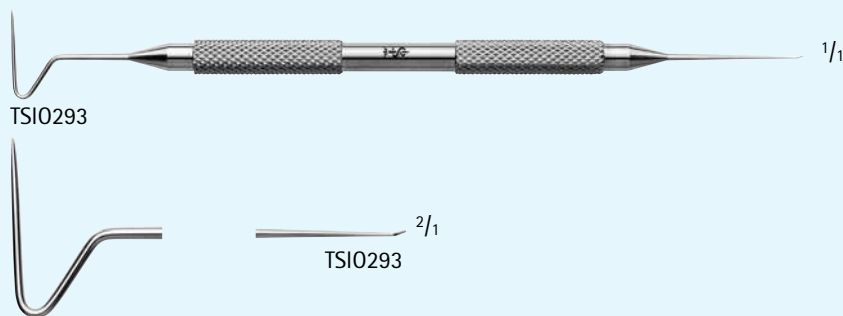

SIEBEL Flap Lifter and Spatula, Double Ended

Catalog Number	Tip	Length (in.)
TSIO293	Z-SHAPED AND 1.5 MM ANG POINT	4 1/8

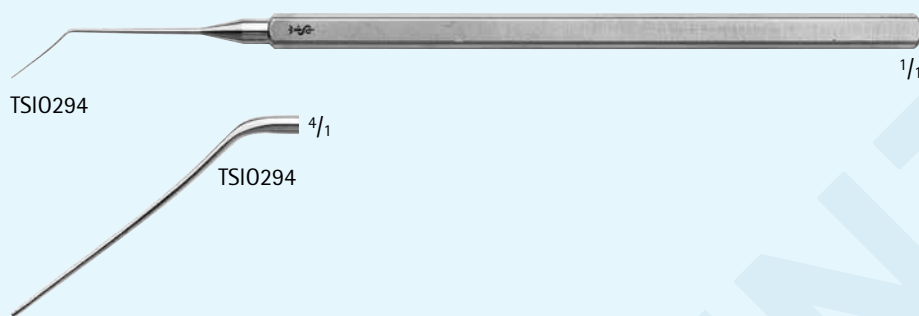

JAFFE Lens Spatula

Catalog Number	Tip	Tip Size (mm)	Length (in.)
TSIO294	FLAT	0.5	4 3/4

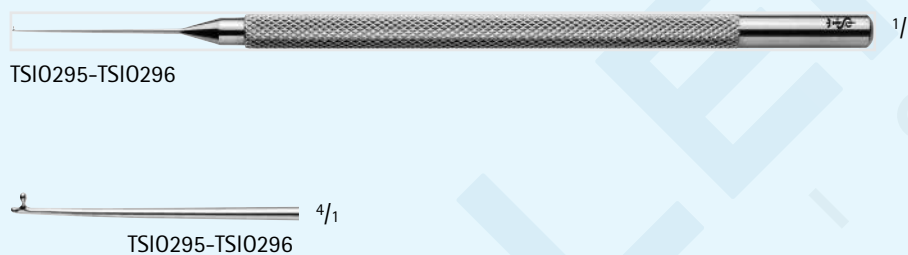

LESTER IOL Manipulator

Catalog Number	Tip	Tip Size (mm)	Shaft	Length (in.)
TSIO295	TEARDROP-SHAPED	0.25	STR	4 1/2
TSIO296	TEARDROP-SHAPED	0.25	ANG	4 1/2

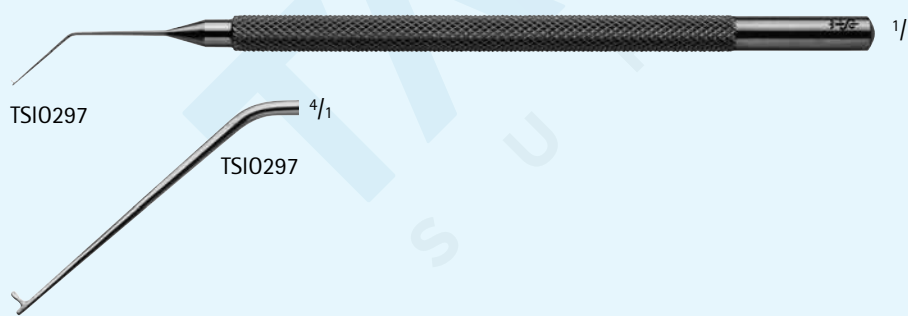

LESTER II Titanium IOL Manipulator

Catalog Number	Tip	Tip Size (mm)	Shaft	Length (in.)
TSIO297	TEARDROP-SHAPED	0.20	ANG	4 1/2

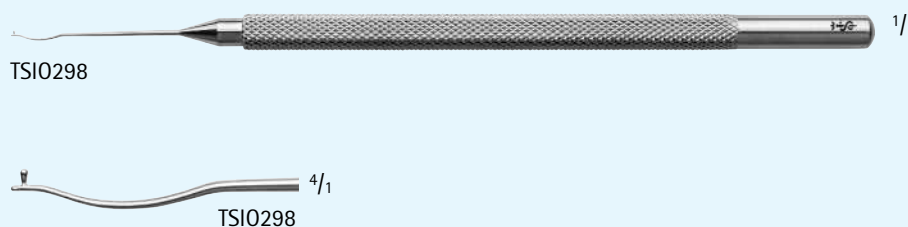

MALONEY IOL Manipulator

Catalog Number	Tip	Tip Size (mm)	Shaft	Length (in.)
TSIO298	TEARDROP-SHAPED	0.25	CVD	4 1/2

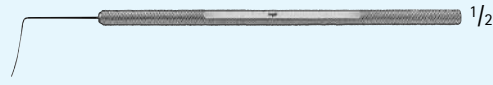

TSIO299

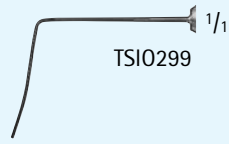

TSIO299

BARRAQUER Cyclodialysis Spatula

Catalog Number	Blade Size (mm)	Blade	Length (in.)
TSIO299	0.5 x 15	ANG	4 7/8



TSIO300

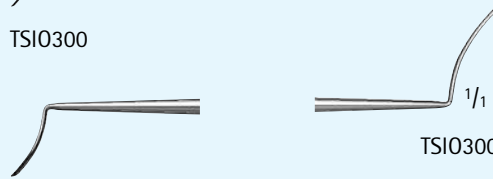

TSIO300

CASTROVIEJO Cyclodialysis Spatula, Double Ended

Catalog Number	Blade Size (mm)	Length (in.)
TSIO300	0.5 x 10 / 0.5 x 15	5 1/8



TSIO301

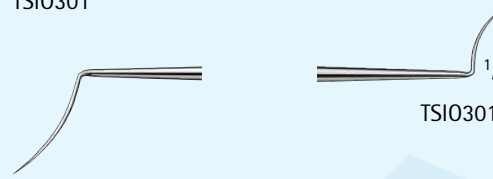

TSIO301

CASTROVIEJO Synechia Spatula, Double Ended

Catalog Number	Blade Size (mm)	Length (in.)
TSIO301	0.5	5 1/4

MA798R



TSIO302



TSIO302

NEW ORLEANS Lens Loop

Catalog Number	Tip	Length (in.)
TSIO302	4 x 10	5 1/2



TSIO303

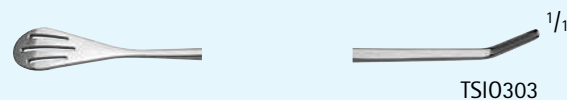

TSIO303

PATON Spatula and Spoon, Double Ended

Catalog Number	Tip	Length (in.)
TSIO303	6 MM WIDE GROOVED SPOON / 1.5 MM FLAT BLADE ANG AT 8 MM	5 1/2



TSIO304



TSIO304

GRAETHER Collar Button

Catalog Number	Tip	Shaft	Length (in.)
TSIO304	0.6 MM BUTTON	ANG 45° 10 MM FROM TIP	4 3/4



TSIO305

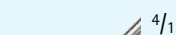

TSIO305

CLAYMAN-JAFFE Lens Hook

Catalog Number	Tip	Tip Size (mm)	Shaft	Length (in.)
TSIO305	ANG 90° BLUNT	0.15	ANG 45° 10 MM FROM TIP	4 1/2



TSIO306

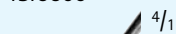

TSIO306

HARRS-SINSKEY Lens Manipulating Hook

Catalog Number	Tip	Tip Size (mm)	Shaft	Handle	Length (in.)
TSIO306	BLUNT	0.25	ANG 45° 10 MM FROM TIP	FLAT	4 1/2



TSIO307



TSIO307



TSIO308

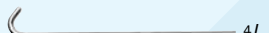

TSIO308



TSIO309

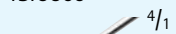

TSIO309



TSIO340



TSIO340



TSIO341



TSIO341

SINSKEY Lens Manipulating Hook

Catalog Number	Tip	Tip Size (mm)	Shaft	Handle	Length (in.)
TSIO307	BLUNT	0.25	STR	FLAT	4 5/8
TSIO308	BLUNT	0.20	MODIFIED CVD	FLAT	4 1/2
TSIO309	BLUNT, REVERSE	0.20	ANG	FLAT	4 1/2
TSIO340	BLUNT	0.25	STR	ROUND	4 1/2
TSIO341	BLUNT	0.25	ANG	ROUND	4 1/2

SINSKEY II Lens Manipulating Hook

Catalog Number	Tip	Tip Size (mm)	Shaft	Handle	Length (in.)
TSIO342	BLUNT	0.2	STR	FLAT	4 1/2
TSIO343	BLUNT	0.2	ANG	FLAT	4 1/2
TSIO344	BLUNT	0.2	STR	ROUND	4 1/2
TSIO345	BLUNT	0.2	ANG	ROUND	4 1/2

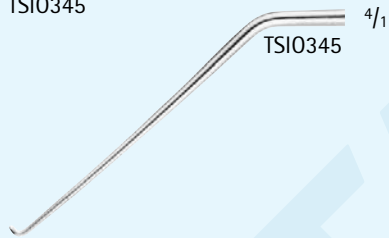
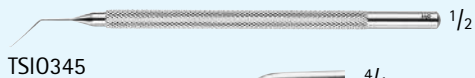
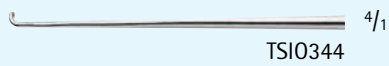
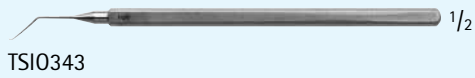
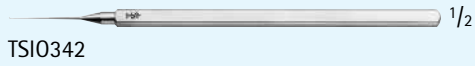

SINSKEY II Titanium Lens Manipulating Hook

Catalog Number	Tip	Tip Size (mm)	Shaft	Handle	Length (in.)
TSIO346	BLUNT	0.2	STR	FLAT	4 1/2
TSIO347	BLUNT	0.2	ANG	ROUND	4 1/2

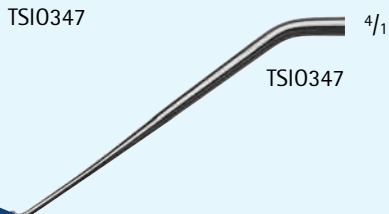

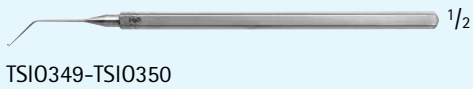

KUGLEN Iris Hook and Lens Manipulator

Catalog Number	Tip	Tip Size (mm)	Shaft	Handle	Length (in.)
TSIO348	K-HOOK	0.5	STR	SQUARE	4 5/8
TSIO349	PUSH-PULL	-	STR	FLAT	4 1/2
TSIO350	PUSH-PULL	-	ANG	FLAT	4 1/2
TSIO351	PUSH-PULL	-	STR	ROUND	4 1/2
TSIO352	PUSH-PULL	-	ANG	ROUND	4 1/2

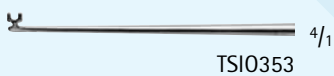

KUGLEN Titanium Iris Hook and Lens Manipulator

Catalog Number	Tip	Shaft	Handle	Length (in.)
TSIO353	K-HOOK	STR	ROUND	4 1/2
TSIO354	PUSH-PULL	ANG	ROUND	4 1/2

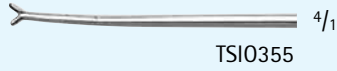
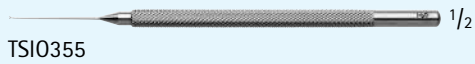

OSHER "Y"-Hook Lens Manipulator

Catalog Number	Tip	Shaft	Length (in.)
TSIO355	Y-SHAPED	STR	4 1/2

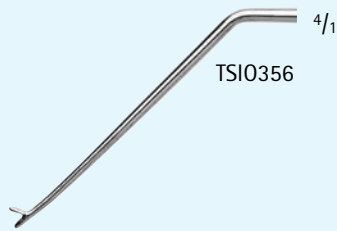
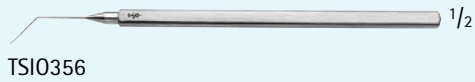

JAFFE-MALTZMAN Lens Manipulating Hook

Catalog Number	Tip	Tip Size (mm)	Shaft	Length (in.)
TSIO356	V-SHAPED	0.15	ANG	4 1/2



MCPHERSON Iris Spatula

Catalog Number	Blade Size (mm)	Length (in.)
TSIO357	1 x 16	4 1/2

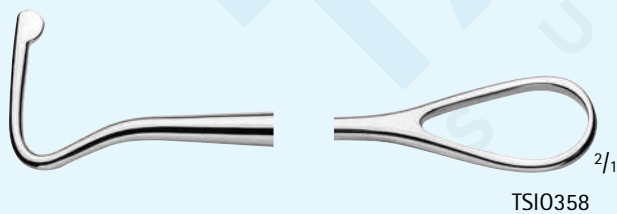

KIRBY Hook and Muscle Loop, Double Ended

Catalog Number	Blade Size (mm)	Length (in.)
TSIO358	5 x 10	6 1/8

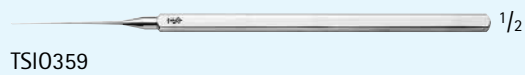

BONN Micro Iris Hook

Catalog Number	Tip	Shaft	Length (in.)
TSIO359	BLUNT	STR	5



TSIO360



TSIO360



TSIO361



TSIO361

JAMESON Muscle Hook

Catalog Number	Size	Tip Size (mm)	Length (in.)
TSIO360	SMALL	9	5 1/4
TSIO361	LARGE	10	5 1/4



TSIO362



TSIO362

GREEN Strabismus Hook

Catalog Number	Tip	Tip Size (mm)	Length (in.)
TSIO362	FLAT	8	5 1/8



TSIO363



TSIO363

Twist Fixation Hook

Catalog Number	Tip	Length (in.)
TSIO363	RIGHT, CLOCKWISE TWIST	4 1/4

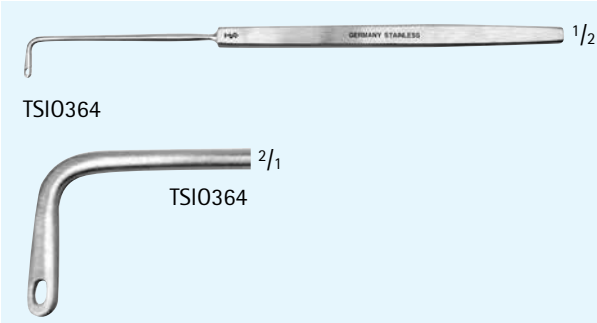

GASS Retinal Detachment Hook

Catalog Number	Length (in.)
TSI0364	5 5/8

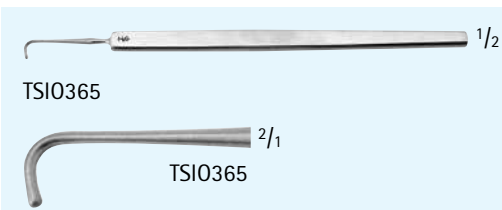

STEVENS Tenotomy Hook

Catalog Number	Tip	Tip Size (mm)	Length (in.)
TSI0365	CVD, BLUNT	5	4 5/8

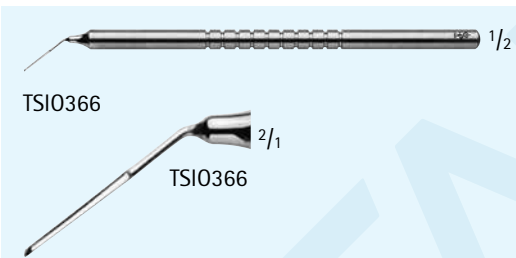

ALFONSO Nucleus Trisector

Catalog Number	Tip Size (mm)	Length (in.)
TSI0366	1.5	4 3/4

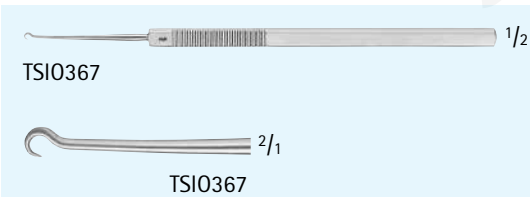

TYRELL Iris Hook

Catalog Number	Tip	Tip Size (mm)	Length (in.)
TSI0367	SHARP	2	4 3/4



TSIO368-TSIO379

FLIERINGA Scleral Fixation Ring

Catalog Number	Diameter (mm)	Description
TSIO368	12-22	SET OF 8 RINGS
TSIO369	12	-
TSIO370	13	-
TSIO371	14	-
TSIO372	15	-
TSIO373	16	-
TSIO374	17	-
TSIO375	18	-
TSIO376	19	-
TSIO377	20	-
TSIO378	21	-
TSIO379	22	-



TSIO380



TSIO380

OSHER-NEUMANN Corneal Marker

Catalog Number	Tip	Length (in.)
TSIO380	8 BLADES	4 1/8



TSIO381



TSIO381

THORNTON Swivel Fixation Ring

Catalog Number	Tip	Diameter (mm)	Length (in.)
TSIO381	BLUNT TEETH	13	4 1/2



TSIO382



TSIO382

MENDEZ Degree Gauge, Calibrated 10° from 0–180°

Catalog Number	Inner Diameter (mm)	Compatible w/	Length (in.)
TSIO382	12	MA836R	4 1/4



TSIO383



TSIO383

BORES Axis Marker

Catalog Number	Compatible w/	Length (in.)
TSIO383	MA833R	4



TSIO384



TSIO384

HENDERSON Degree Gauge

Catalog Number	Tip	Compatible w/	Length (in.)
TSIO384	BEVELED FACE, SMOOTH	MA837R	4 1/8

For use with TSIO386



TSIO385



TSIO385

HENDERSON Alignment Marker

Catalog Number	Tip	Compatible w/	Length (in.)
TSIO385	BLUNT PIN MARKINGS AT 3, 6 AND 9 O'CLOCK	MA834R AND MA837R	4

For use with MA837R



TSIO386

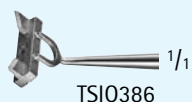

TSIO386

HENDERSON Toric IOL Marker

Catalog Number	Tip	Compatible w/	Length (in.)
TSIO386	2.5 MM AXIS MARKS	MA834R	4



TSIO387-TSIO390



TSIO387



TSIO388



TSIO389



TSIO390

BORES Optical Zone Marker

Catalog Number	Inner Diameter (mm)	Length (in.)
TSIO387	3.5	4
TSIO388	6	4 1/8
TSIO389	7	4 1/8
TSIO390	8	4 1/8



TSIO391-TSIO395



TSIO391



TSIO392



TSIO393



TSIO394

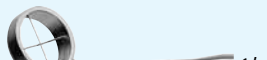

TSIO395

HOFFER Optical Zone Marker

Catalog Number	Inner Diameter (mm)	Length (in.)
TSIO391	4.25	4
TSIO392	5	4
TSIO393	5.5	4
TSIO394	6	4
TSIO395	8	4 1/8

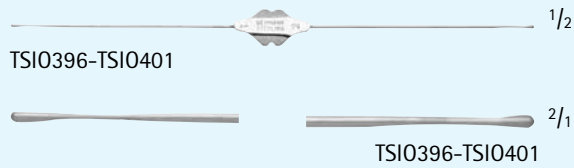

WILLIAMS Lacrimal Probe, Double Ended

Catalog Number	Tip Size (#)	Length (in.)
TSIO396	0000/000	5 1/8
TSIO397	00/0	5 1/2
TSIO398	1/2	5 1/2
TSIO399	3/4	5 1/2
TSIO400	5/6	5 1/2
TSIO401	7/8	5 1/2

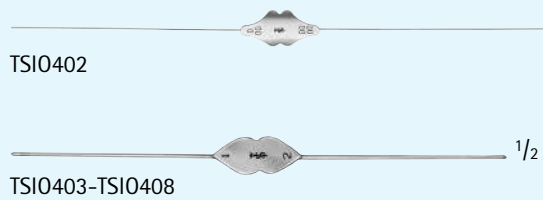

BOWMAN Lacrimal Probe, Double Ended

Catalog Number	Tip Size (#)	Tip Size (mm)	Description	Length (in.)
TSIO402	-	-	SET OF 6	-
TSIO403	0000/000	-	-	5 5/8
TSIO404	00/0	0.7 / 0.8	-	5 1/8
TSIO405	1/2	0.9 / 1.1	-	5 1/8
TSIO406	3/4	1.3 / 1.4	-	5 1/8
TSIO407	5/6	1.5 / 1.6	-	5 1/8
TSIO408	7/8	1.8 / 1.9	-	5 1/8

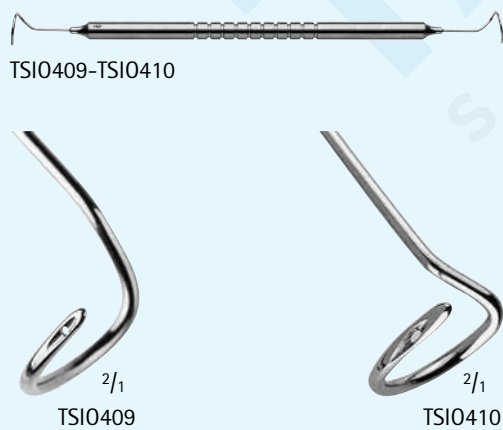

Pigtail Lacrimal Probe, Double Ended, W/ Suture Holes

Catalog Number	Tip	Diameter (mm)	Length (in.)
TSIO409	BLUNT	8	5 1/8
TSIO410	BLUNT	8	6 1/8

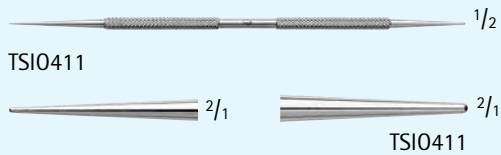

CASTROVIEJO Lacrimal Dilator, Double Ended

Catalog Number	Tip	Length (in.)
TSIO411	FINE TAPPER/ MEDIUM TAPER	4 3/4

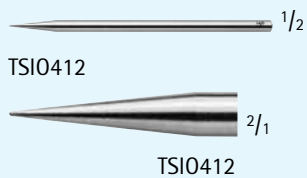

RUEDEMANN Lacrimal Dilator

Catalog Number	Tip	Length (in.)
TSIO412	12 MM TAPER	2 3/4

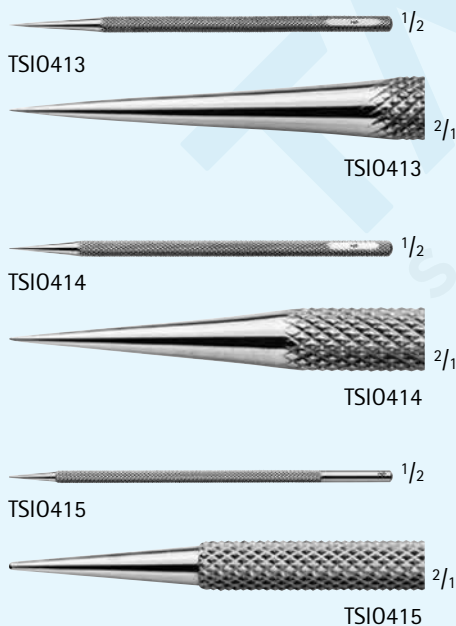

WILDER Lacrimal Dilator

Catalog Number	Tip	Tip Size (mm)	Size	Length (in.)
TSIO413	LONG TAPER	23	1	4
TSIO414	MEDIUM TAPER	18	2	4
TSIO415	SHORT TAPER	13	3	4

CATALANO Lacrimal Intubation Set,
Single Use

Catalog Number	Description
TSIO416	TWO 0.7 MM PROBES ATTACHED TO 250 MM LONG SILICONE TUBING

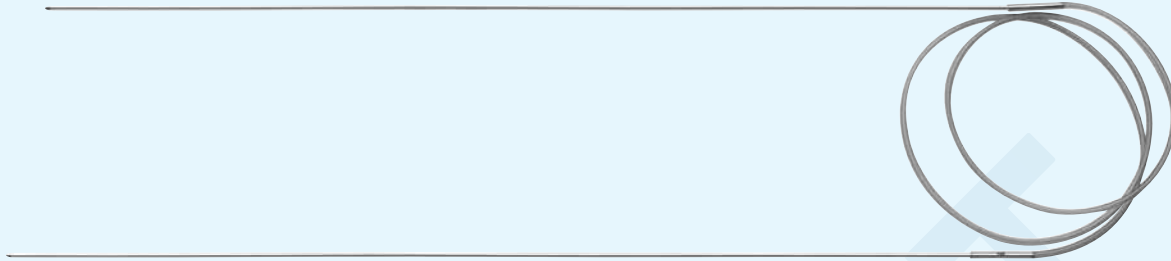

TSIO416

JACKSON Lacrimal Intubation Set,
Single Use

Catalog Number	Description
TSIO417	TWO 0.9 MM PROBES ATTACHED TO 250 MM LONG SILICONE TUBING

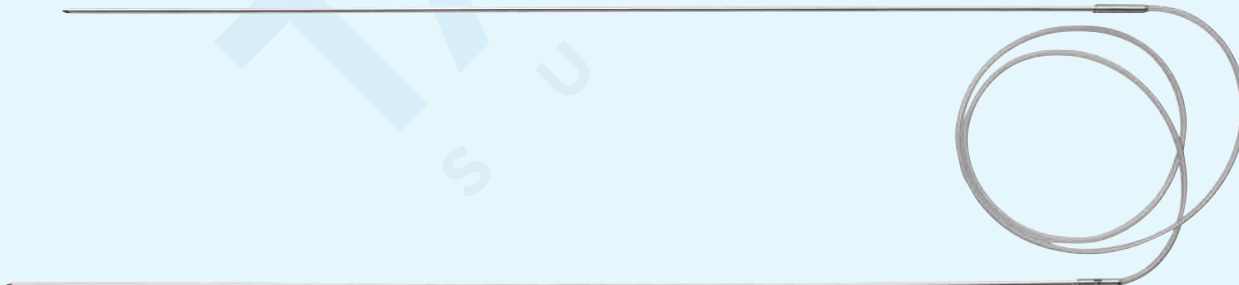

TSIO417

CRAWFORD Lacrimal Intubation Set, Single Use

Catalog Number	Description
TSIO418	TWO OLIVE-TIPPED 0.8 MM PROBES ATTACHED TO 250 MM LONG SILICONE TUBING



TSIO418

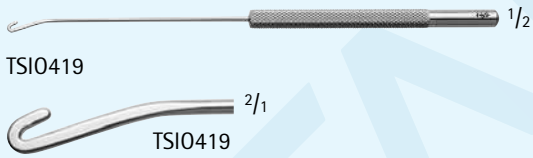

TSIO419

TSIO419

CRAWFORD Retrieving Hook

Catalog Number	Compatible w/	Length (in.)
TSIO419	MA922R	5 1/8

Lacrimal Cannula

Catalog Number	Tip	Tip Size (Gauge)	Shaft	Length (in.)
TSIO420	REINFORCED, MALLEABLE	23	STR	1 3/8
TSIO421	REINFORCED, MALLEABLE	23	CVD	1 3/8
TSIO422	-	23	STR	1

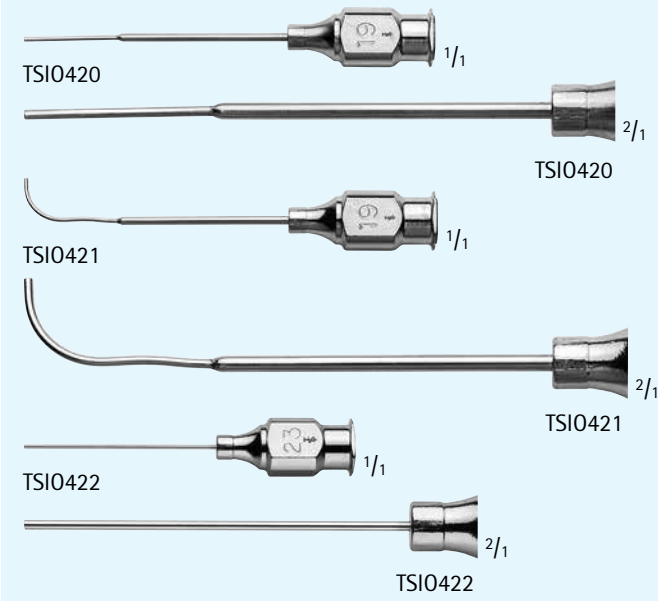

SHAHINIAN Lacrimal Cannula

Catalog Number	Tip	Tip Size (Gauge)	Shaft	Length (in.)
TSIO423	0.3 MM SIDE PORT	23	STR	3/8

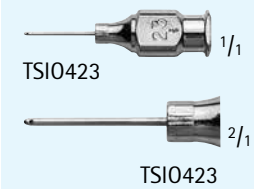

RANDOLPH Cyclodialysis Cannula

Catalog Number	Tip	Tip Size (Gauge)	Shaft	Length (in.)
TSIO424	THIN	19	ANG 13 MM FROM TIP	1 3/8
TSIO425	DEL	19	ANG 13 MM FROM TIP	1 1/4

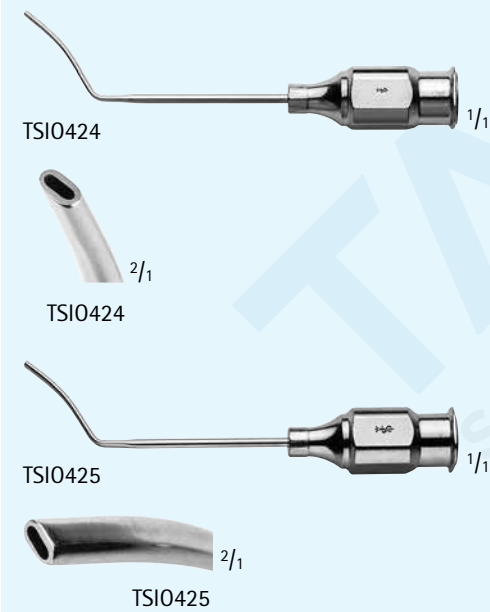

TROUTMAN Olive Tip Cannula

Catalog Number	Tip	Tip Size (Gauge)	Shaft	Length (in.)
TSIO426	1	25	SLIGHT-CVD	1

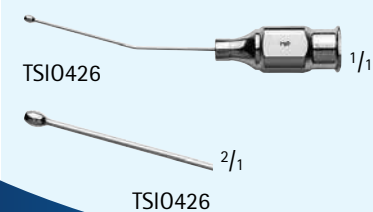



TSIO427



TSIO427

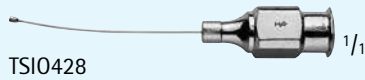

TSIO428



TSIO428

JENSEN Capsule Polisher, Roughened Tip, W/ Front Opening

Catalog Number	Tip	Tip Size (Gauge)	Shaft	Length (in.)
TSIO427	OLIVE	25	CVD	1
TSIO428	OLIVE	27	CVD	1



TSIO429

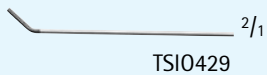

TSIO429

KNOLLE Capsule Polisher, Roughened Tip

Catalog Number	Tip	Tip Size (Gauge)	Length (in.)
TSIO429	2 MM ANG	30	3/4



TSIO430-TSIO433

BISHOP-HARMON Anterior Chamber Irrigator, 19 GA, Angled

Catalog Number	Description	Length (in.)
TSIO430	COMPLETE SET	-
TSIO431	SILICONE BULB, 28 x 55 MM	-
TSIO432	PLASTIC ADAPTER, F/ USE W/ MA935	-
TSIO433	CANNULA	1

TSIO430 Includes:
1 Cannula TSIO433
1 Plastic Adaptor TSIO432
1 Silicone Bulb TSIO431



TSIO434



TSIO434

Hydrodissection Cannula

Catalog Number	Tip	Tip Size (Gauge)	Shaft	Length (in.)
TSIO434	FLATTENED, FRONT OPENING	25	ANG	3/4

BRACKEN Irrigating Cannula

Catalog Number	Tip	Tip Size (Gauge)	Shaft	Length (in.)
TSIO435	FLATTENED BEVELED, FRONT OPENING	19	CVD	1 1/4



SLADE LASIK Cannula

Catalog Number	Tip	Tip Size (Gauge)	Shaft	Length (in.)
TSIO436	FLATTENED SPATULA, FRONT OPENING	26	ANG	1/2



BURATTO Cannula

Catalog Number	Tip	Tip Size (Gauge)	Shaft	Length (in.)
TSIO437	FLATTENED, 1 FRONT AND 2 SIDE PORTS	25	ANG	1

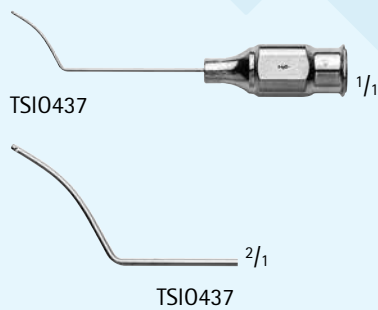

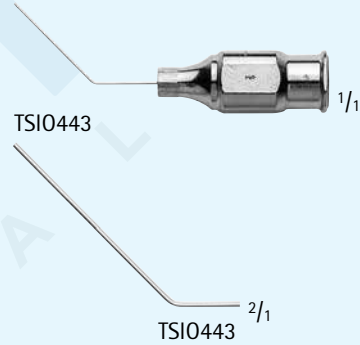
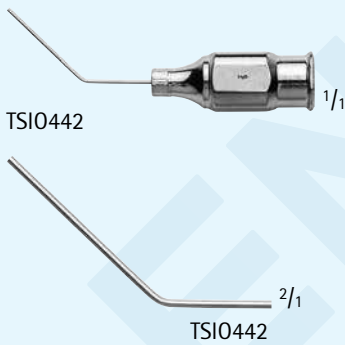
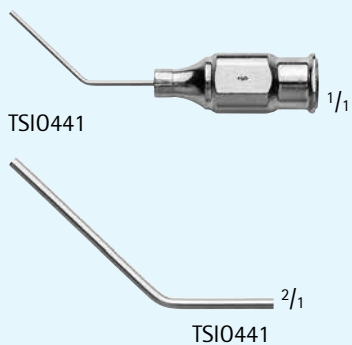
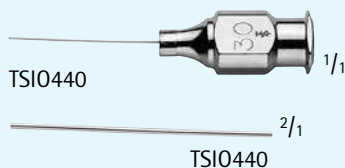
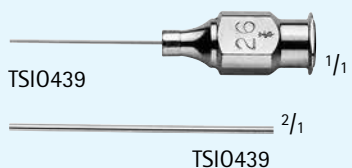
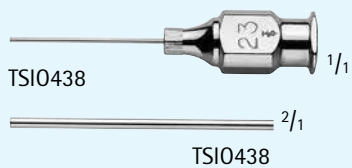

MCINTYRE Anterior Chamber Cannula

Catalog Number	Tip	Tip Size (Gauge)	Shaft	Length (in.)
TSIO438	BLUNT	23	STR	3/4
TSIO439	BLUNT	26	STR	3/4
TSIO440	BLUNT	30	STR	3/4
TSIO441	BLUNT	23	ANG 12 MM FROM TIP	3/4
TSIO442	BLUNT	26	ANG 12 MM FROM TIP	3/4
TSIO443	BLUNT	30	ANG 12 MM FROM TIP	3/4

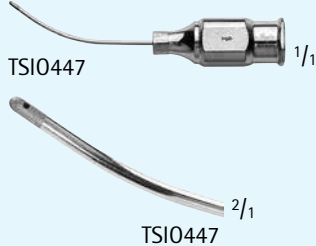
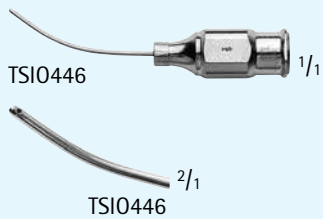
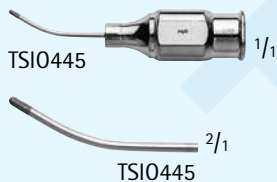
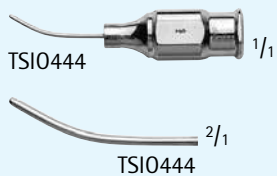

SIMCOE Cortex Extractor, Side Port

Catalog Number	Tip	Tip Size (Gauge)	Shaft	Length (in.)
TSIO444	SMOOTH, 0.3 MM	23	CVD	1/2
TSIO445	ROUGHENED, 0.3 MM	23	CVD	1/2
TSIO446	SMOOTH, 0.3 MM	23	CVD	3/4
TSIO447	ROUGHENED, 0.3 MM	23	CVD	3/4

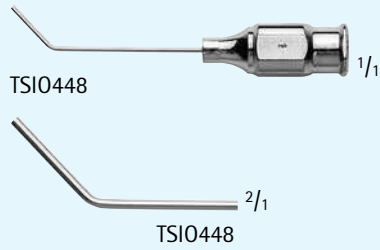

MORRISON Aspirating Cannula, Front Opening

Catalog Number	Tip	Tip Size (Gauge)	Shaft	Length (in.)
TSIO448	SMOOTH, BLUNT	23	ANG 7 MM FROM TIP	1

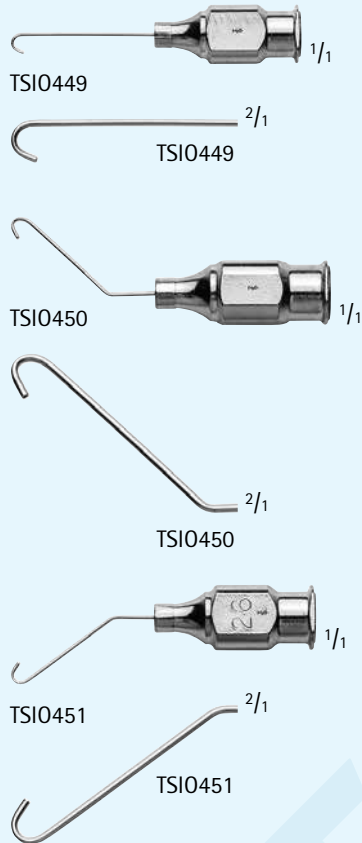

MCINTYRE-BINKHORST Cannula, Front Opening, Hook Shape

Catalog Number	Tip	Tip Size (Gauge)	Shaft	Length (in.)
TSIO449	SMOOTH, BLUNT	26	STR	3/4
TSIO450	SMOOTH, BLUNT	26	RIGHT ANG	3/4
TSIO451	SMOOTH, BLUNT	26	LEFT ANG	3/4

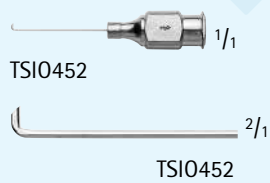

CHANG Nucleus Hydrodissector Cannula

Catalog Number	Tip	Tip Size (Gauge)	Shaft	Length (in.)
TSIO452	FLAT, BEVELED OPENING	27	RIGHT ANG	1/2

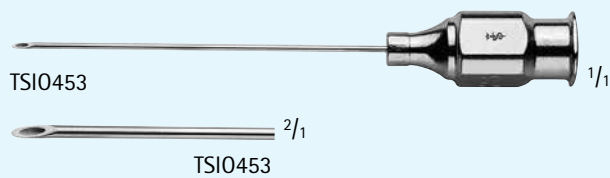

ATKINSON Retrobulbar Needle

Catalog Number	Tip Size (Gauge)	Shaft	Length (in.)
TSIO453	23	STR	1 3/8

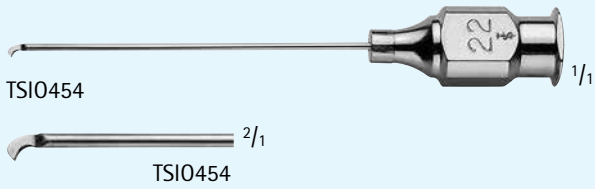

KELMAN Cystotome

Catalog Number	Tip Size (Gauge)	Shaft	Length (in.)
TSIO454	22	STR	1 1/4

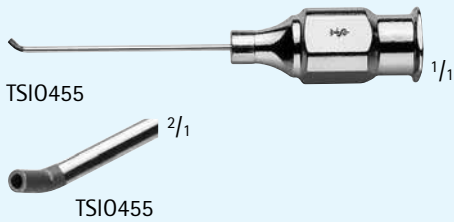

KRATZ Capsule Scrubber

Catalog Number	Tip	Tip Size (Gauge)	Shaft	Length (in.)
TSIO455	ROUGHENED	23	ANG	3/4

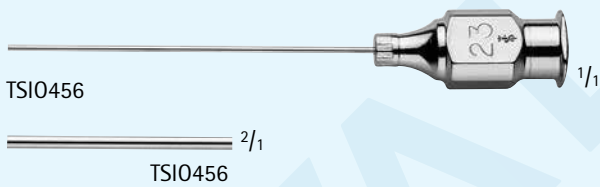

Backflush Infusion Cannula

Catalog Number	Tip Size (Gauge)	Shaft	Length (in.)
TSIO456	23	STR	1 3/8

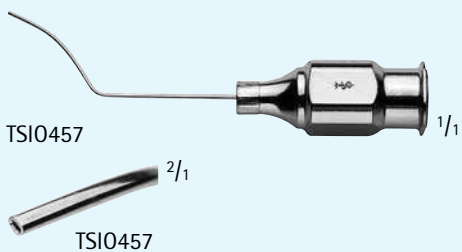

NICHAMIN Hydrodissection Cannula

Catalog Number	Tip Size (Gauge)	Shaft	Length (in.)
TSIO457	25	ANG	1

Air Injection Cannula

Catalog Number	Tip Size (mm)	Tip Size (Gauge)	Shaft	Length (in.)
TSIO458	5	27	ANG	3/4
TSIO459	5	30	ANG	3/4

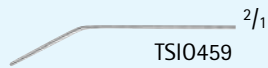
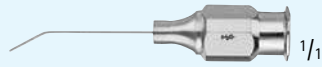
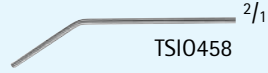
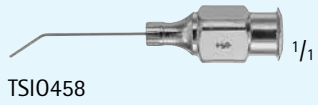

WEST Lacrimal Cannula, Side Port

Catalog Number	Tip Size (mm)	Tip Size (Gauge)	Shaft	Length (in.)
TSIO460	0.3	23	STR	1 1/4

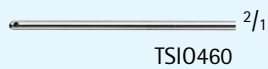

SIMCOE Irrigating Aspiring Unit

Catalog Number	Tip Size (Gauge)	Description
TSIO461	23	ASPIRATION THROUGH 0.3 MM TOP PORT, IRRIGATION THROUGH FRONT PORT, USES 225 MM TUBING

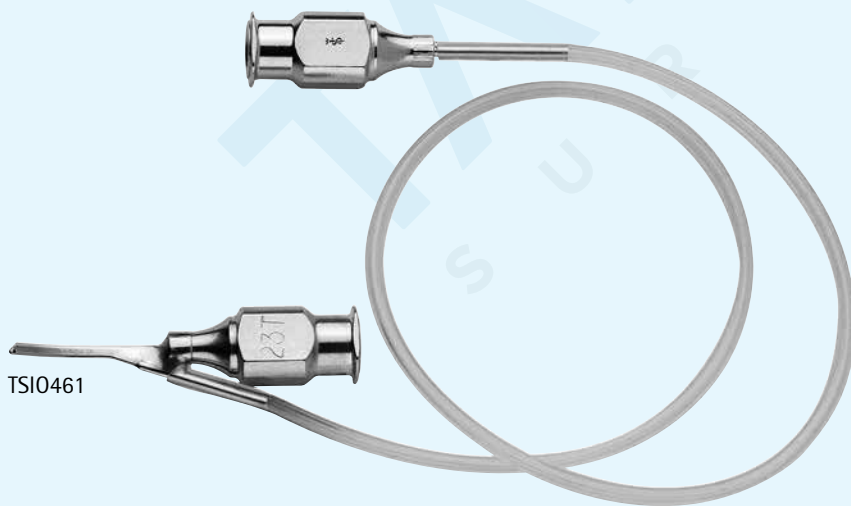



TSIO462



TSIO463

BRAUNSTEIN Fixed Caliper, Double Ended

Catalog Number	Tip Size (mm)	Length (in.)
TSIO462	3.0 / 3.5	2 3/4
TSIO463	3.5 / 4.0	2 3/4

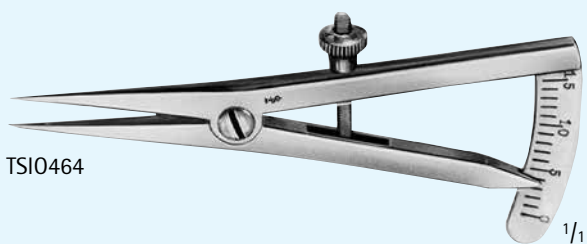

TSIO464

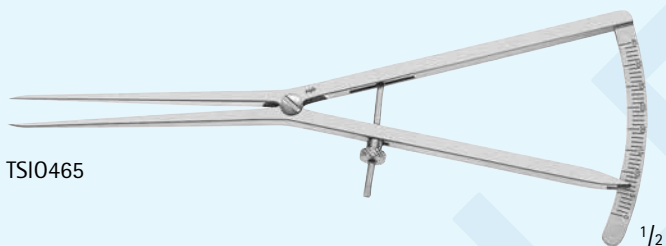

TSIO465

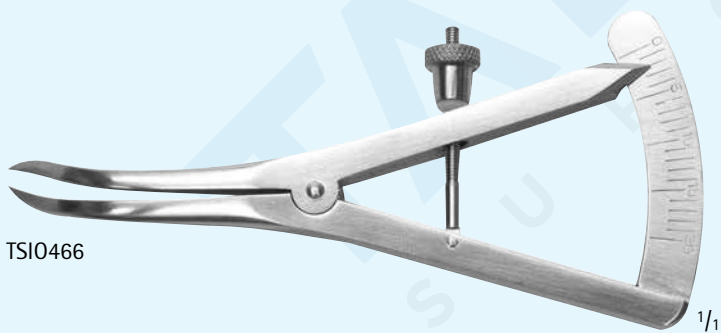

TSIO466

CASTROVIEJO Eye Caliper

Catalog Number	Tip	Description	Length (in.)
TSIO464	STR	0 - 15 MM RANGE	3 1/8
TSIO465	STR	0 - 40 MM RANGE	6 3/4
TSIO466	CVD	0 - 20 MM RANGE	3 3/8



TSIO467

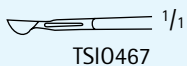

TSIO467

AKAHOSHI Combo Prechopper, Cross-Action

Catalog Number	Jaw	Jaw Length (mm)	Length (in.)
TSIO467	STR	4.5	4 1/4

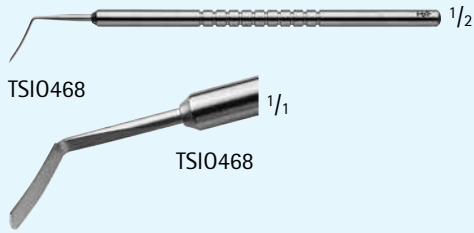

Corneal Dissector Knife

Catalog Number	Blade	Shaft	Length (in.)
TSIO468	CVD	ANG	4 1/2



TOOKE Corneal Knife

Catalog Number	Blade	Blade Size (mm)	Length (in.)
TSIO469	STR	3 x 18	4 3/4

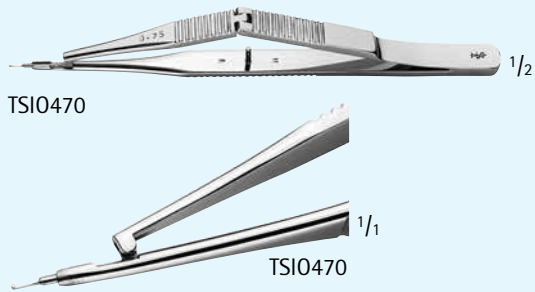

KELLY-DESCEMET'S Membrane Punch

Catalog Number	Diameter (mm)	Length (in.)
TSIO470	1	5 1/8

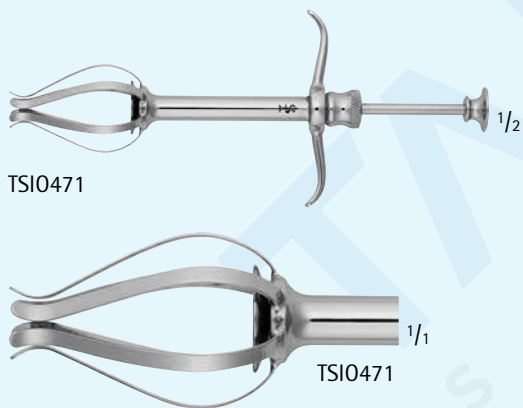

CARTER Sphere Introducer

Catalog Number	Length (in.)
TSIO471	5

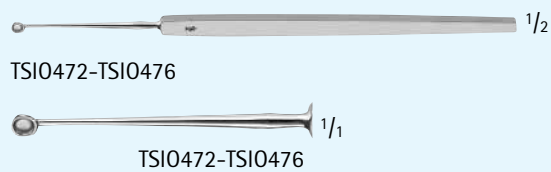

MEYERHOEFFER Chalazion Curette

Catalog Number	Tip Size (#)	Cup (mm)	Length (in.)
TSIO472	0	1.5	5
TSIO473	1	1.7	5
TSIO474	2	2	5
TSIO475	3	2.5	5
TSIO476	4	3.5	5



Sialkot, Pakistan Office

Contact Person: Hasham khalid



Address: A/1, Small Industries Estate, Near SIE Telephone Exchange PTCL, Sialkot – Punjab 51310, Pakistan.



Yakshan Khalid: +92 331 478 6083



info@tsurgicalinstruments.com
Talentsurgicalaustralia@gmail.com



Australia Office:

Contact Person: Hasham khalid



Pelham Crescent, Wyndham Vale, VIC 3024 Australia



Hasham Khalid: +61 430 855 424 / +61 481 335 786



info@tsurgicalinstruments.com
Talentsurgicalaustralia@gmail.com



TALENT
S U R G I C A L

