



TALENT
S U R G I C A L



UROLOGY SURGICAL INSTRUMENTS

We make more than 1385 surgical instruments.

We are proud to manufacture premium quality instruments.

Certification:

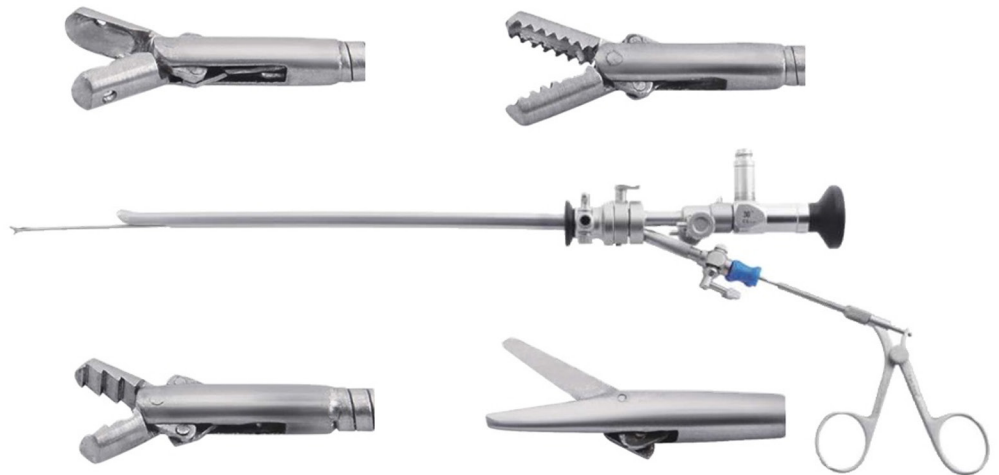

Registered with Therapeutic Goods Australia (Scissors)
Registered with Therapeutic Goods Australia (Needle Holder)
Registered with Therapeutic Goods Australia (Forceps)

www.tsurgicalinstruments.com



TALENT

S U R G I C A L





Urology

Needles	004
Instruments for Radical Prostatectomy	005 - 008
Forceps and Clamps	009 - 019
Retractors	020 - 024
Catheters, Guides and Sounds	025

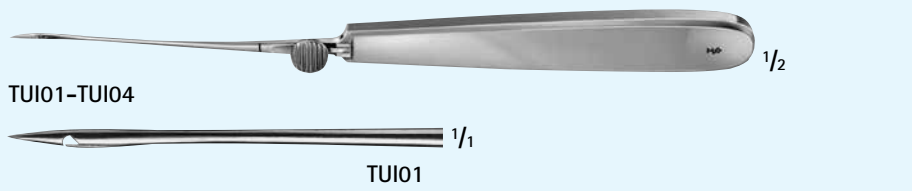

REVERDIN Needle

Catalog Number	Tip	Length (in.)
TUI01	SLIGHT-CVD	7 3/4
TUI02	CVD	7 3/4
TUI03	HEAVY-CVD	7 3/4
TUI04	X-HEAVY-CVD	7 3/4
TUI05	SLIGHT-CVD	9
TUI06	CVD	9
TUI07	HEAVY-CVD	9
TUI08	X-HEAVY-CVD	9

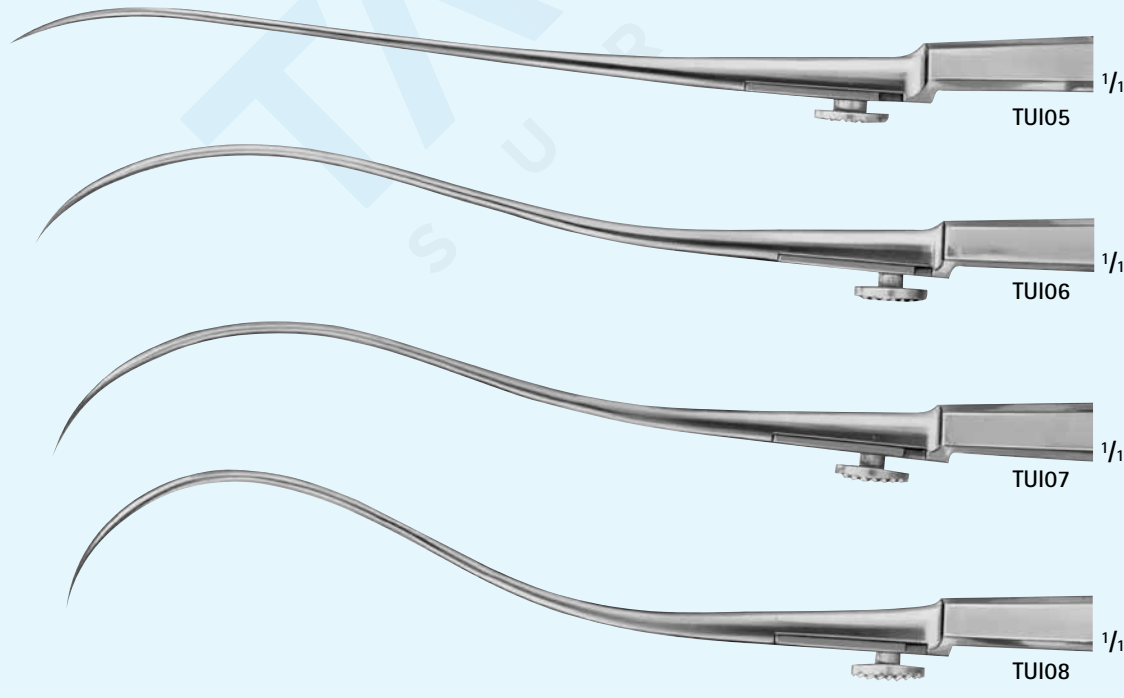
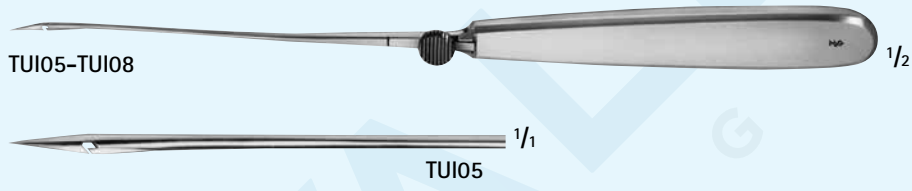
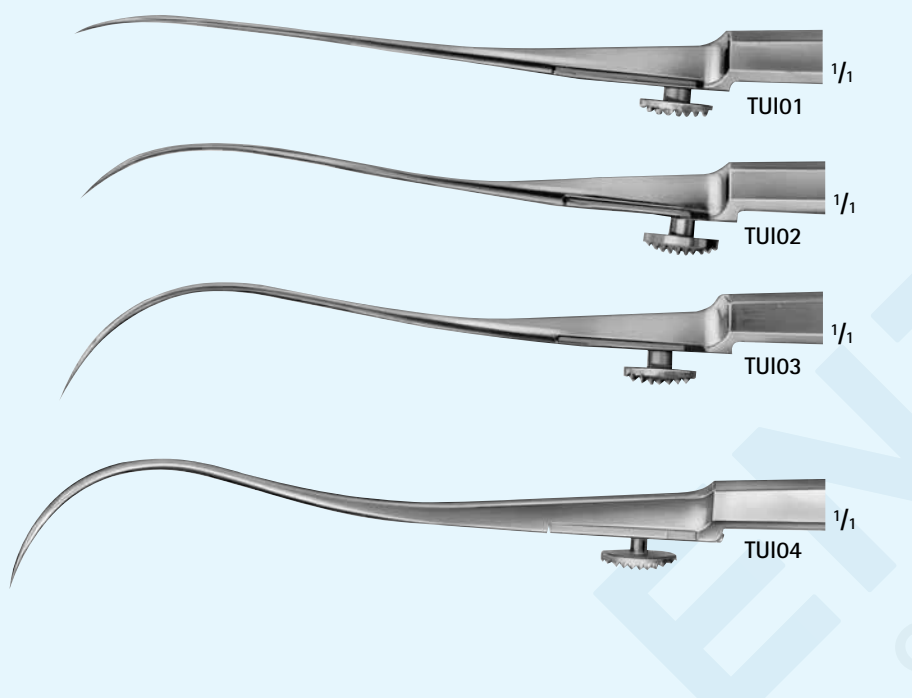

BARRÉ Instruments for Radical Prostatectomy

BARRÉ Scalpel Handle #3L, F/ Blade nos. 10-15, 40, 42

Catalog Number	Blade Shape	Blade Angle	Length (in.)
TUI09	ANG	12°	9 3/4



TUI09

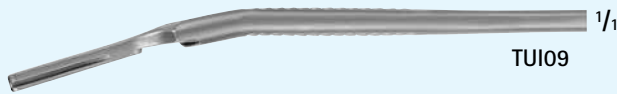

TUI09

BARRÉ Scalpel Handle #3XL, F/ Blade nos. 10-15, 40, 42

Catalog Number	Blade Shape	Length (in.)
TUI10	STR	9 3/4



TUI10



TUI10

BARRÉ Scalpel Handle #3XL, F/ Blade nos. 10-15, 40, 42

Catalog Number	Blade Shape	Blade Angle	Length (in.)
TUI11	ANG	25°	9 3/4



TUI11



TUI11

BARRÉ Instruments for Radical Prostatectomy

Dorsal Venous Complex Clamp

Catalog Number	Blade Angle	Length (in.)
TUI12	10°	8 1/4

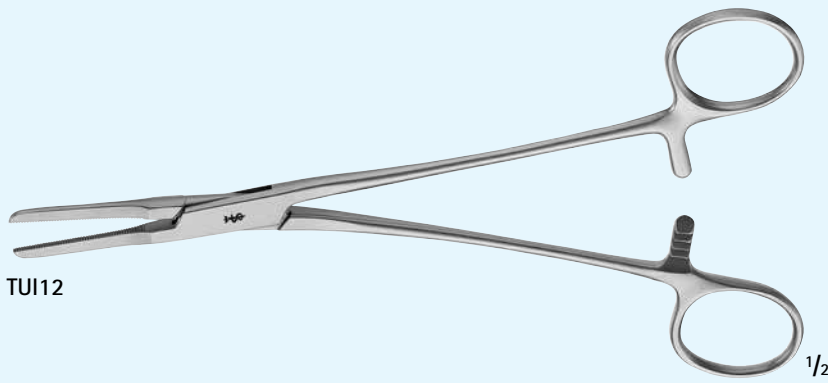

TUI12

1/2

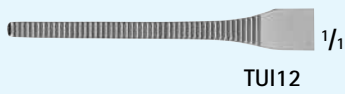

TUI12

1/1

BARRÉ Nerve Sparing Scissors

Catalog Number	Tip	Blade Shape	Length (in.)
TUI13	S/S	CVD	11

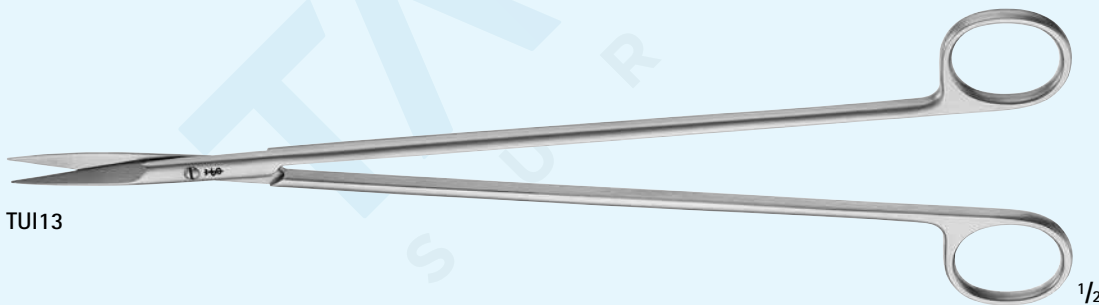

TUI13

1/2

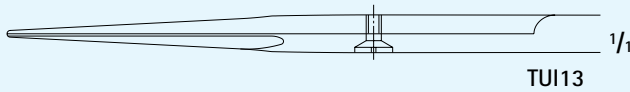

TUI13

1/1

BARRÉ Instruments for Radical Prostatectomy

BARRÉ Nerve Sparing Dissector

Catalog Number	Tip	Length (in.)
TUI14	X-FINE	11
TUI15	FINE	11

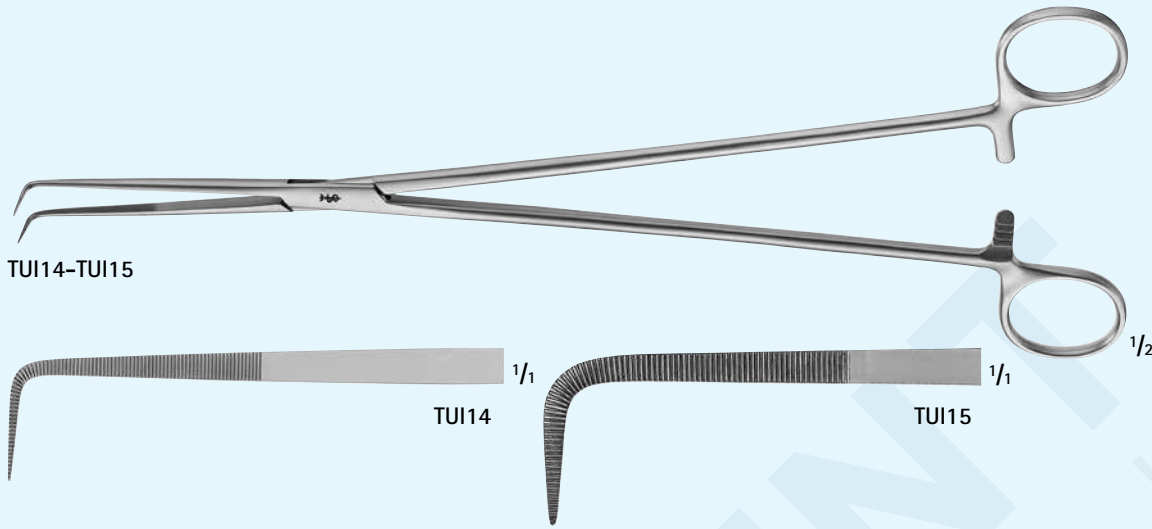

BARRÉ Prostate Retractor

Catalog Number	Length (in.)
TUI16	14 1/4



BARRÉ Urethra Retractor

Catalog Number	Tip	Length (in.)
TUI17	SMALL	10 1/4
TUI18	LARGE	10 1/4
TUI19	—	15 3/8

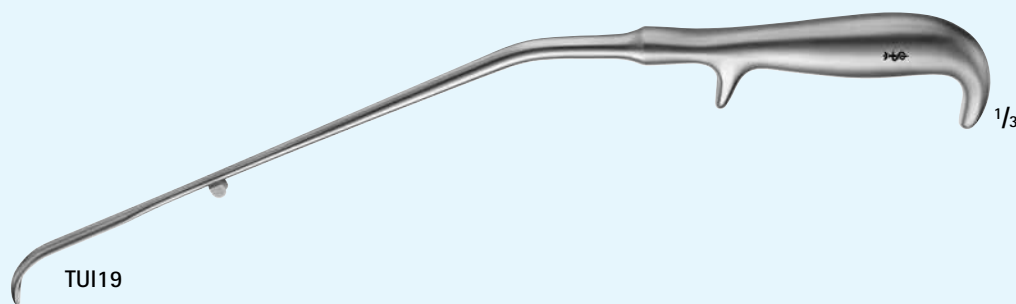

BARRÉ Instruments for Radical Prostatectomy

BARRÉ Suture Holding Frame

Catalog Number	Length (in.)
TUI20	18 1/4

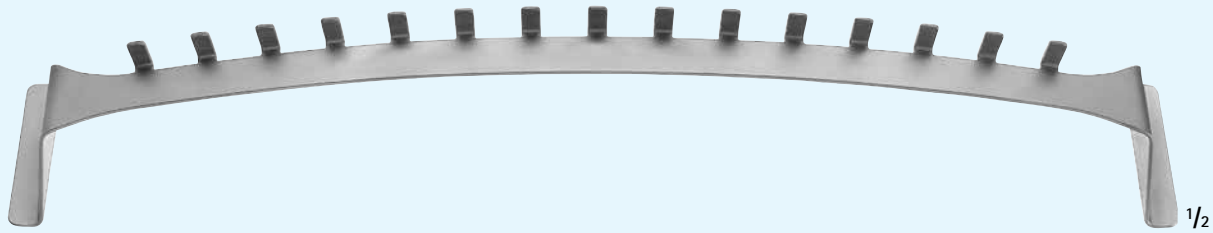

TUI20

BARRÉ Prostatectomy Retractor

Catalog Number	Description	Blade Size, Depth x Width (in.)	Length (in.)
TUI21	COMPLETE RETRACTOR SYSTEM	-	
TUI22	RETRACTOR ONLY	-	
TUI23	MUENSTER OCTANGULAR NOTCH ROD	-	7 7/8
TUI24	MUENSTER UNIVERSAL CONNECTING CLAMP	-	2 3/8
TUI25	BARRÉ COLD LIGHT SUPPORT	-	
TUI26	BARRÉ RETRACTOR BLADES PAIR OF BLADES 2" DEPTH x 2 1/4" WIDTH	2 x 2 3/4	
TUI27	LATERAL BLADE MALLEABLE 2" DEPTH x 7 1/2" WIDTH	2 x 7 1/2	7 1/2
TUI28	CENTER BLADE 2 1/4" DEPTH x 2 3/4" WIDTH	2 1/4 x 2 3/4	9 1/4



TUI21



TUI22



TUI23



TUI24



TUI25



TUI26



TUI27

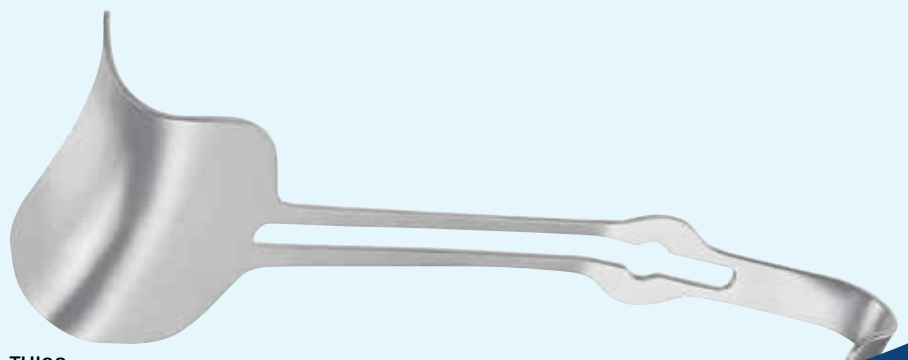

TUI28

TUI21 Full Set includes:

- TUI22
- TUI23
- TUI24
- TUI25
- TUI26
- TUI27
- TUI28

GUYON Atraumatic Kidney Clamp

Catalog Number	Length (in.)
TUI29	9
TUI30	9 1/2

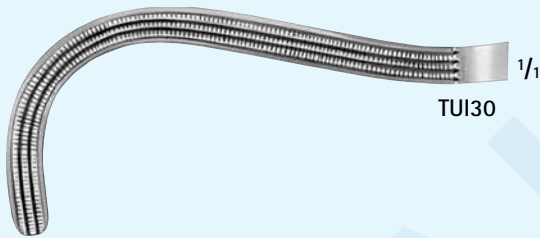
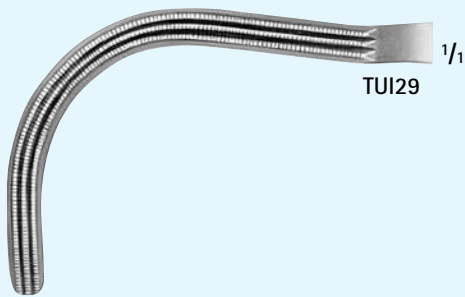
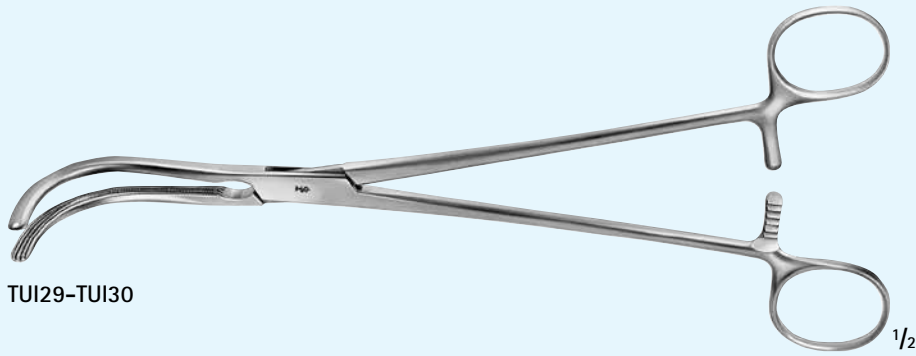

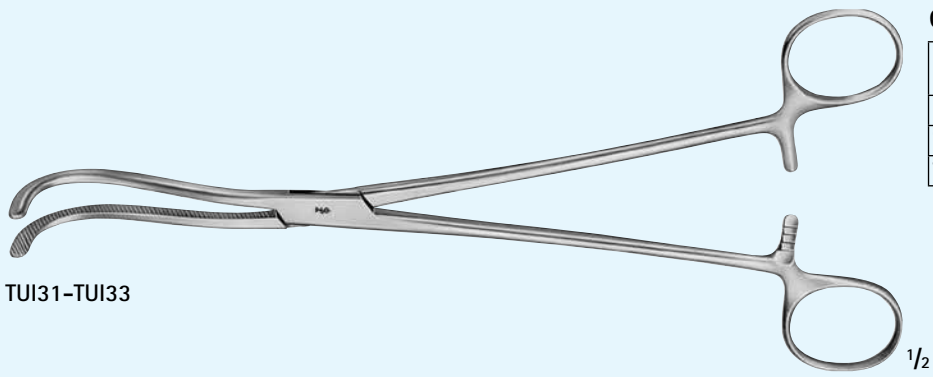

GUYON Kidney Clamp

Catalog Number	Length (in.)
TUI31	9
TUI32	9 1/4
TUI33	11

TUI31-TUI33

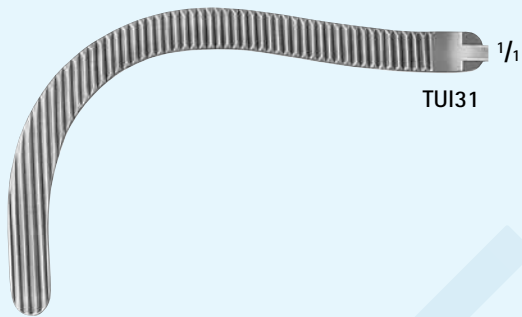

TUI31

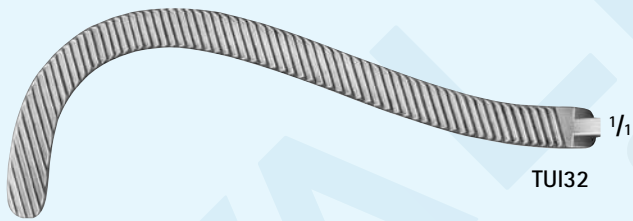

TUI32

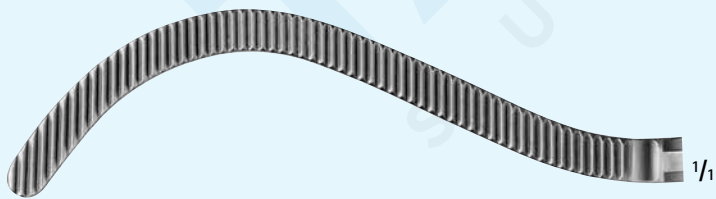

TUI33

STILLE Kidney Clamp

Catalog Number	Length (in.)
TUI34	8 7/8
TUI35	9 1/2

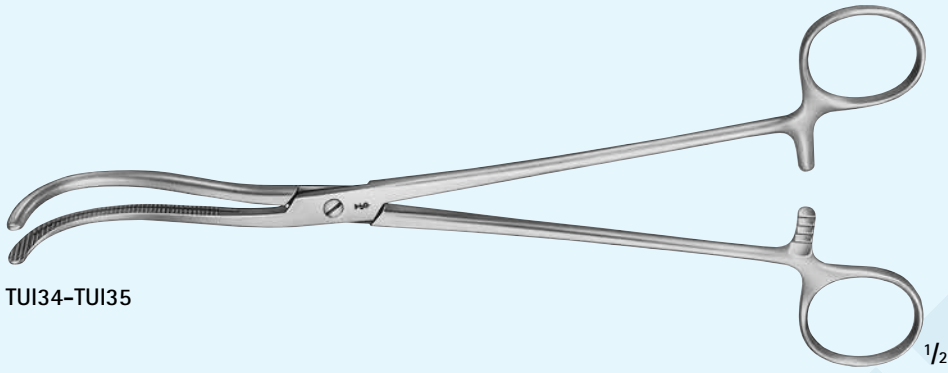

TUI34-TUI35

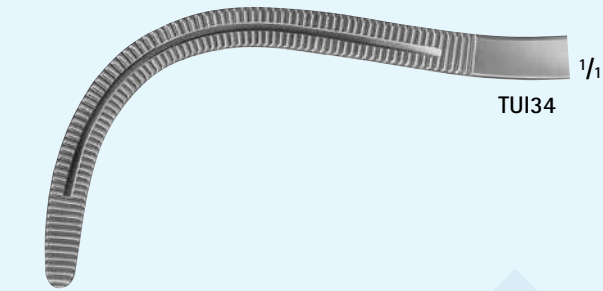

TUI34

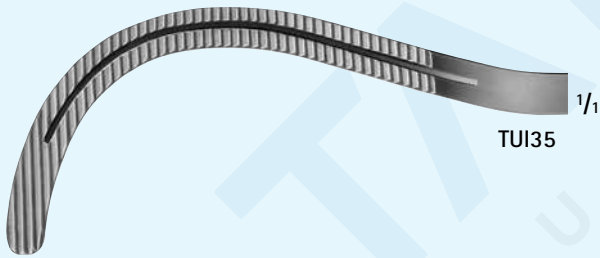

TUI35

HERRICK Kidney Clamp

Catalog Number	Length (in.)
TUI36	8 7/8

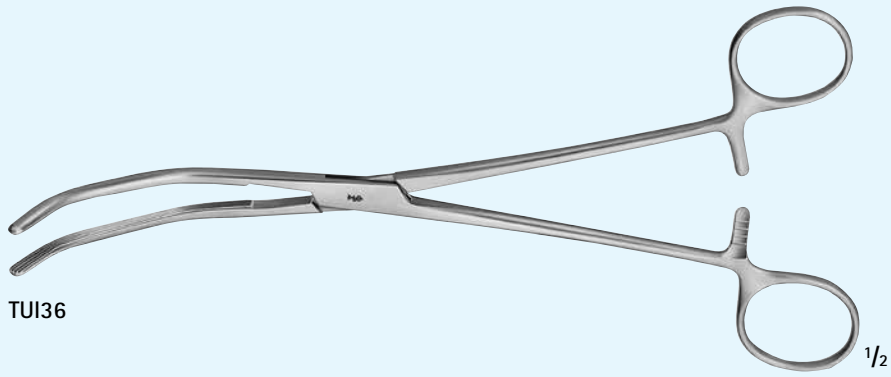

TUI36

1/2

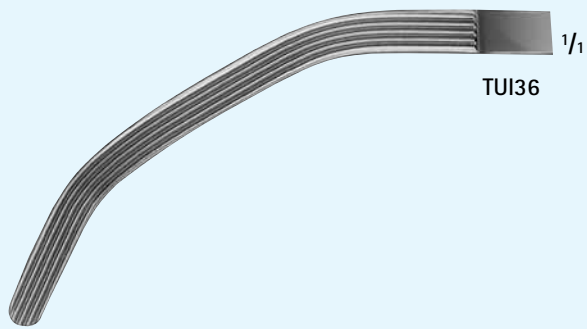

TUI36

1/1

Ureter Atraumatic Forceps

Catalog Number	Length (in.)
TUI37	9 1/2

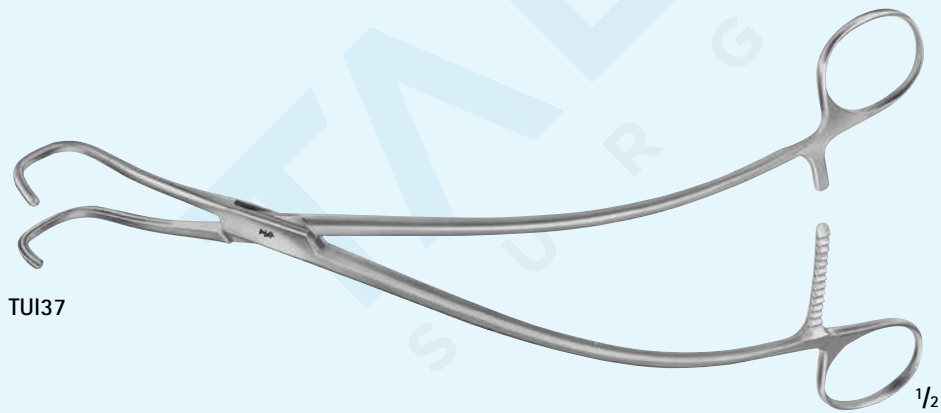

TUI37

1/2

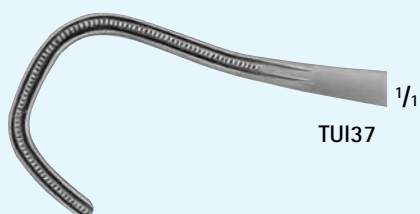

TUI37

1/1

HEIMING Kidney Stone Forceps

Catalog Number	Jaw	Length (in.)
TUI38	SLIGHT-CVD	6 3/4
TUI39	HEAVY-CVD	6 1/4

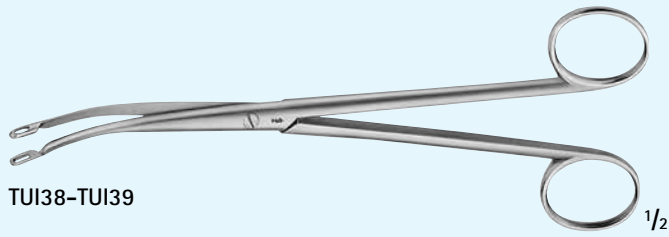

TUI38-TUI39

1/2

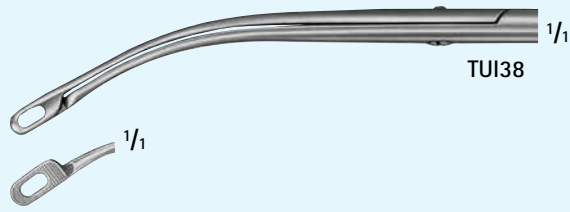

TUI38

1/1

1/1

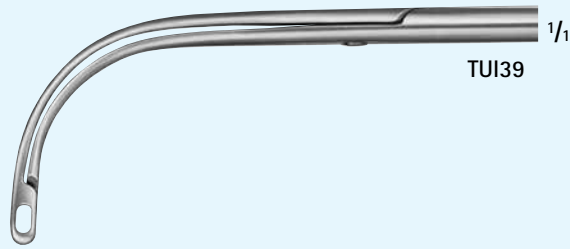

TUI39

1/1

RANDALL Kidney Stone Forceps

Catalog Number	Jaw	Length (in.)
TUI40	CVD	7 1/2
TUI41	HEAVY-CVD	7 1/2

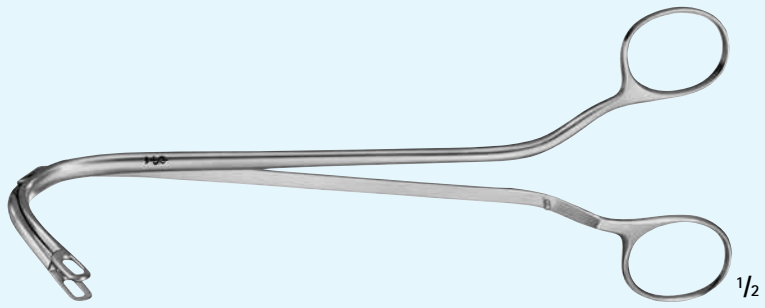

TUI40-TUI41

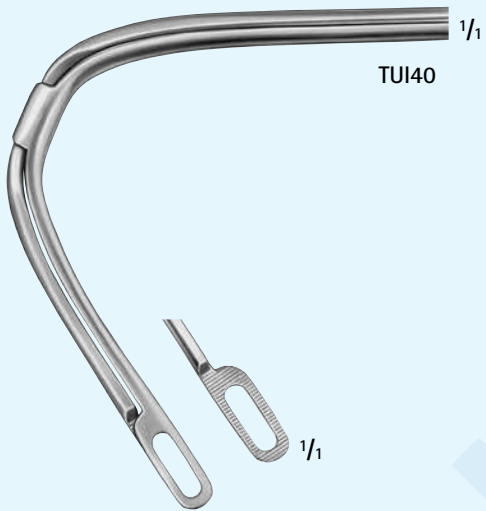

TUI40

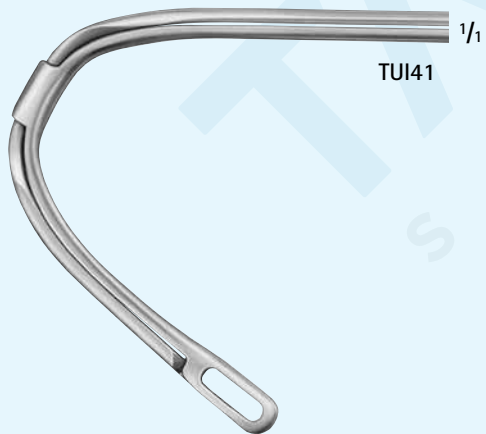

TUI41

RANDALL Kidney Stone Forceps
(continued)

Catalog Number	Jaw	Length (in.)
TUI42	SLIGHT-CVD	8 7/8
TUI43	CVD	8 7/8
TUI44	HEAVY-CVD	8 7/8
TUI45	HEAVY CVD, VERY DELICATE	9
TUI46	U-CVD	8 7/8
TUI47	90° ANG	9 5/8

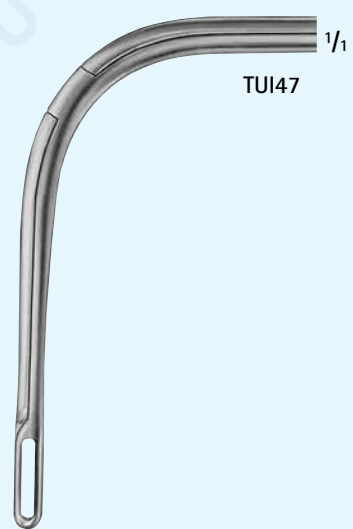
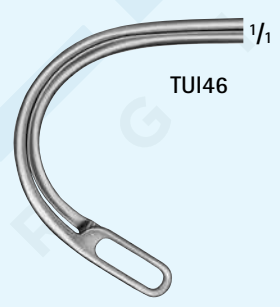
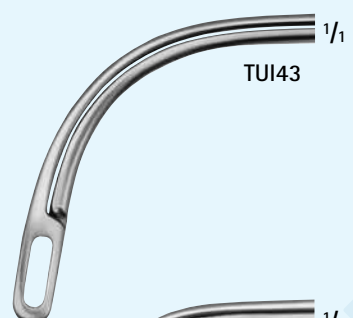
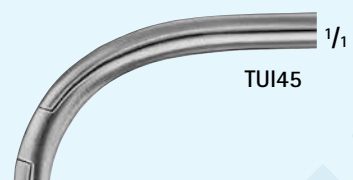
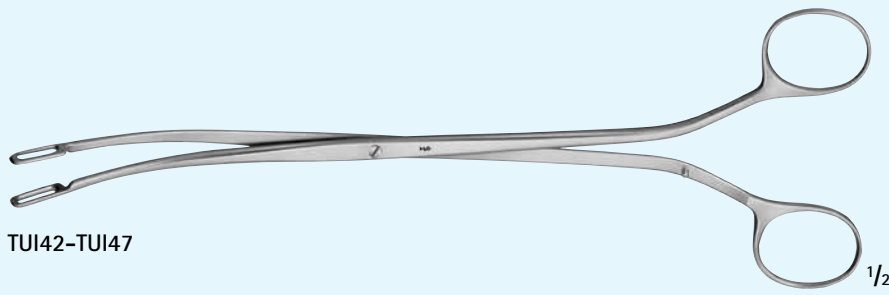

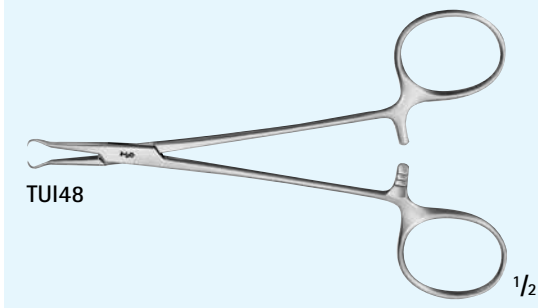

Genitourinary Forceps (F/ No Scalpel Set)

Catalog Number	Length (in.)
TUI48	5

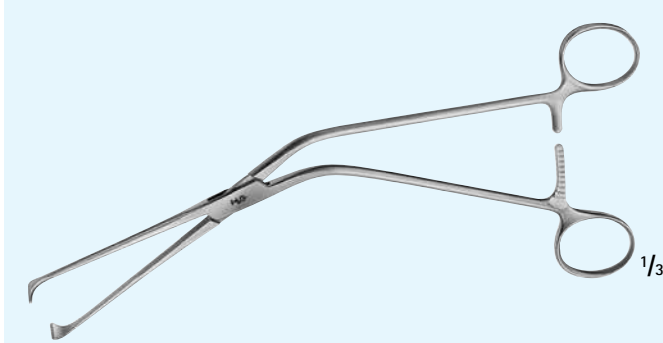

MILLIN Atraumatic Lobe Forceps

Catalog Number	Length (in.)
TUI49	9 5/8

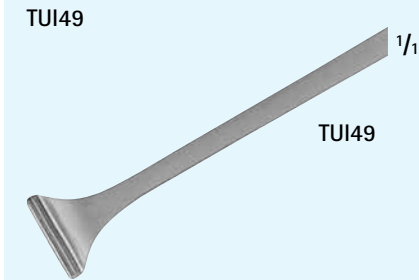

MILLIN Atraumatic T-Shaped Lobe Forceps

Catalog Number	Length (in.)
TUI50	9 1/4

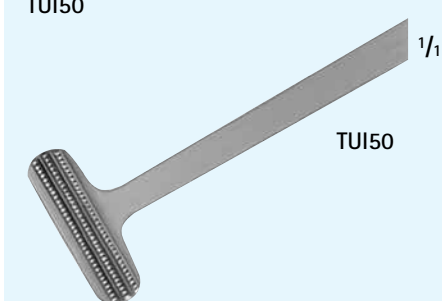

MATHIEU Foreign Body Forceps

Catalog Number	Shaft Length (in.)
TUI51	7 1/2

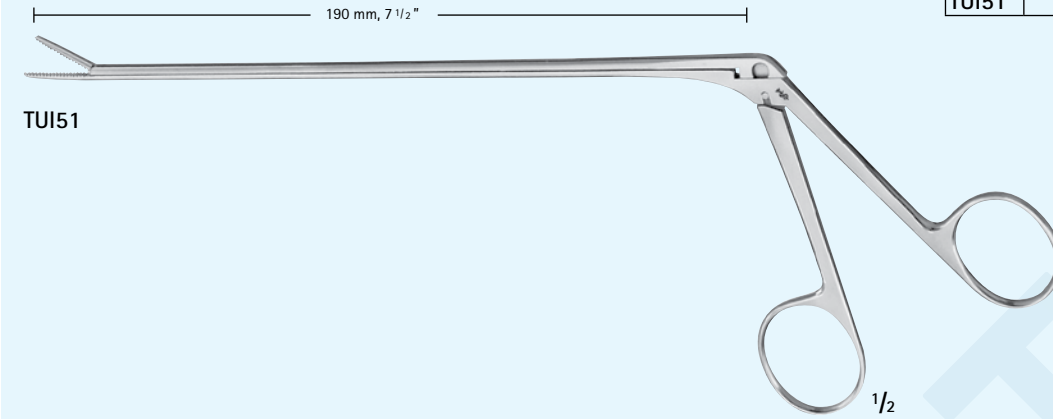

Spermatic Cord Fixation Clamp

Catalog Number	Length (in.)
TUI52	5 3/4

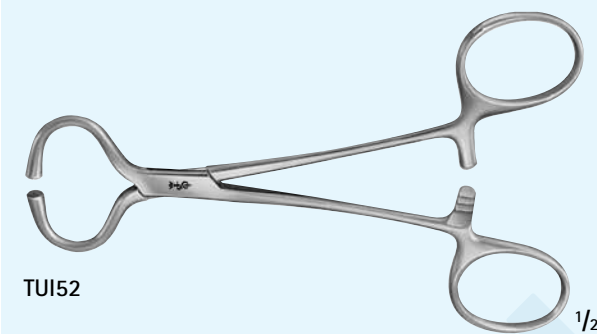

LEADER Vas Isolation Forceps

Catalog Number	Length (in.)
TUI53	5 1/4

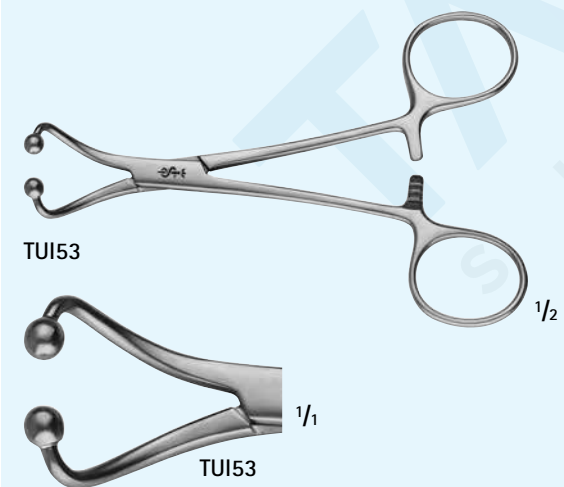

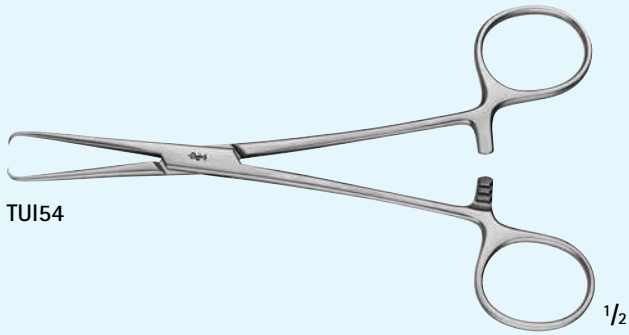

TUI54

1/2

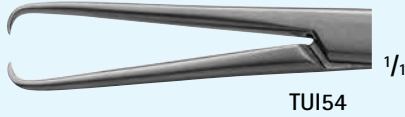

TUI54

1/1

SANDERS Vasectomy Forceps

Catalog Number	Tip	Length (in.)
TUI54	1 x 1 PRONGS	6 1/8

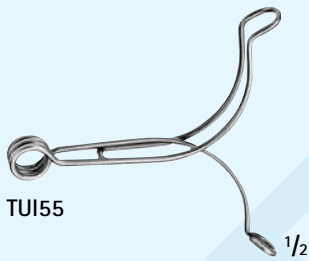

TUI55

1/2

STOCKMANN Penis Clamp

Catalog Number	Length (in.)
TUI55	2 3/4



TUI56

1/2

STRAUSS Penis Clamp

Catalog Number	Length (in.)
TUI56	5 1/8

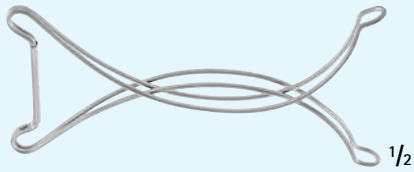

TUI57

ZIPSER Meatus Clamp

Catalog Number	Length (in.)
TUI57	4 1/4

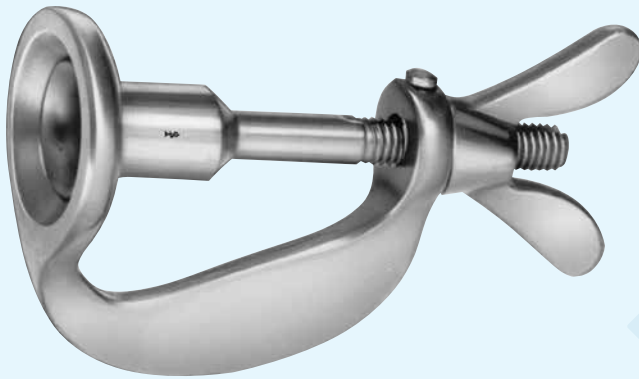

TUI58-TUI60

WINKELMANN Circumcision Clamp

Catalog Number	Diameter (mm)
TUI58	12
TUI59	16
TUI60	20

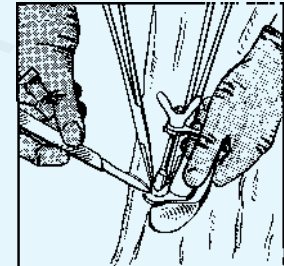
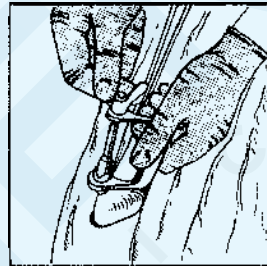

Assisted by two hemostats or ligatures the foreskin is pushed over the bell-shaped protection rod and the glans is placed into it. Next, the wing-nut is tightened as close as possible, so the foreskin is annular compressed. The foreskin is cut off with a scalpel adjacent to the compression ring. The circumcision clamp remains in place for a few minutes to avoid bleeding. If any large vein, specially the frenular artery, is cut, a ligature must be set. The advantage of the method described is the cosmetically favorable scar which is left after rejection of the small necrotized portion.

LOWSLEY Prostatic Tractor

Catalog Number	Tip	Tip Size (FR)	Working Length (in.)	Length (in.)
TUI61	STR	20	9	12 1/4
TUI62	CVD	20	9 1/2	12 3/4



TUI61-TUI62



TUI61-TUI62

YOUNG Prostatic Tractor, Short

Catalog Number	Tip Size (mm)	Length (in.)
TUI63	25 x 25	8 5/8



TUI63

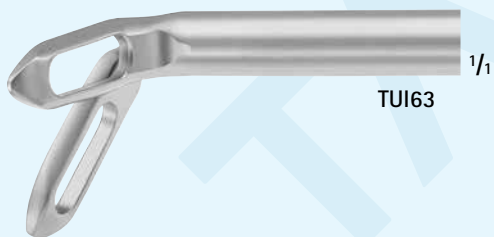

TUI63

LEGUEU Bladder Spatula Retractor

Catalog Number	Blade Size (mm)	Length (in.)
TUI64	35 / 90	10 1/4

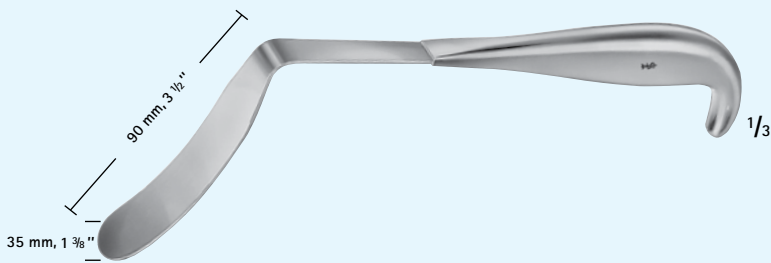

TUI64

WYLIE Renal Vein Retractor

Catalog Number	Blade Size (mm)	Length (in.)
TUI65	25 x 100	13 3/4
TUI66	25 x 175	12 3/4



TUI65-TUI66

TALENT
SURGICAL

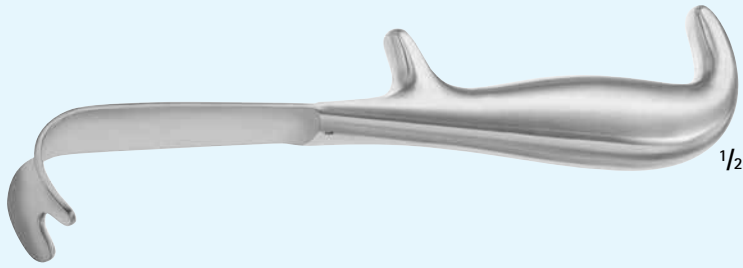

TUI67

1/2

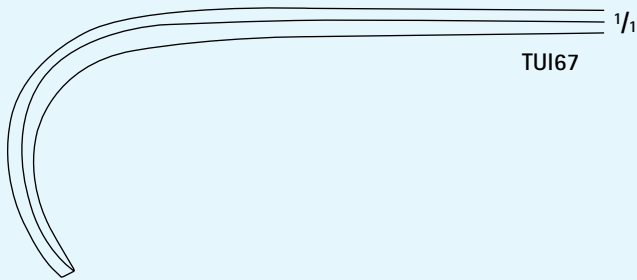

TUI67

1/1

YOUNG Bulb Retractor

Catalog Number	Blade Size (mm)	Length (in.)
TUI67	25 x 25	8 5/8

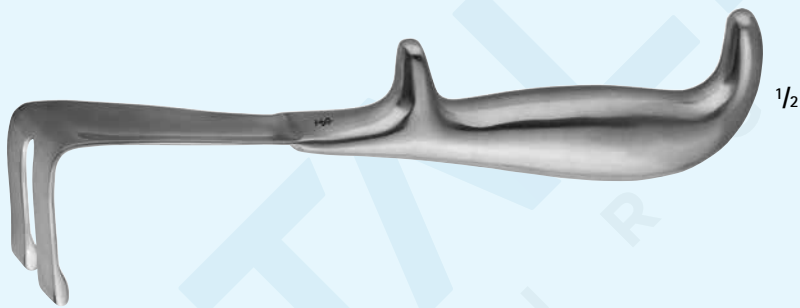

TUI68

1/2

YOUNG Prostatic Retractor, Bifurcated Blade W/ Deep Slots

Catalog Number	Blade Size (mm)	Length (in.)
TUI68	1 1/2 x 1 5/8	7 7/8

YOUNG Lateral Retractor

Catalog Number	Blade Size (mm)	Length (in.)
TUI69	50 x 11	8 1/4

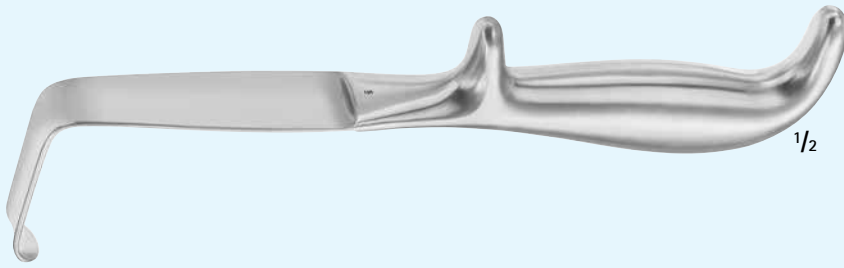

1/2

TUI69

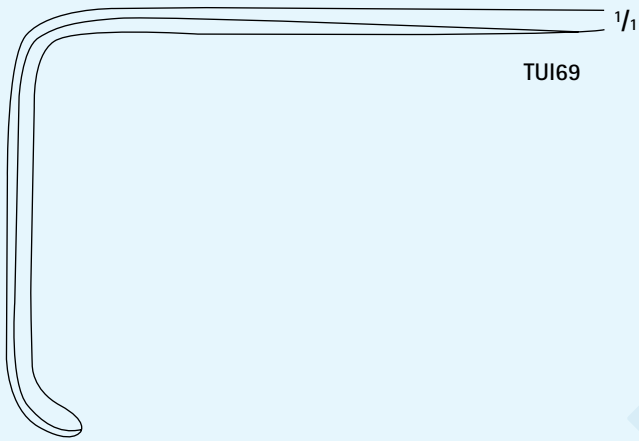

1/1

TUI69

YOUNG Anterior Retractor

Catalog Number	Blade Size (mm)	Length (in.)
TUI70	60 x 40	7 5/8

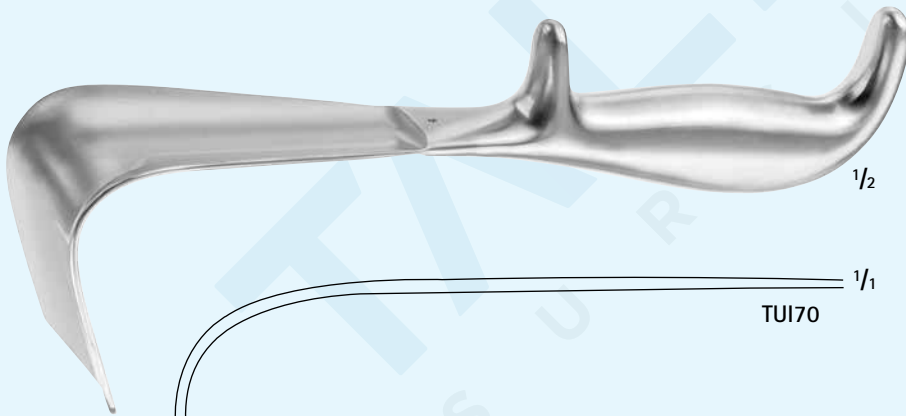

1/2

TUI70

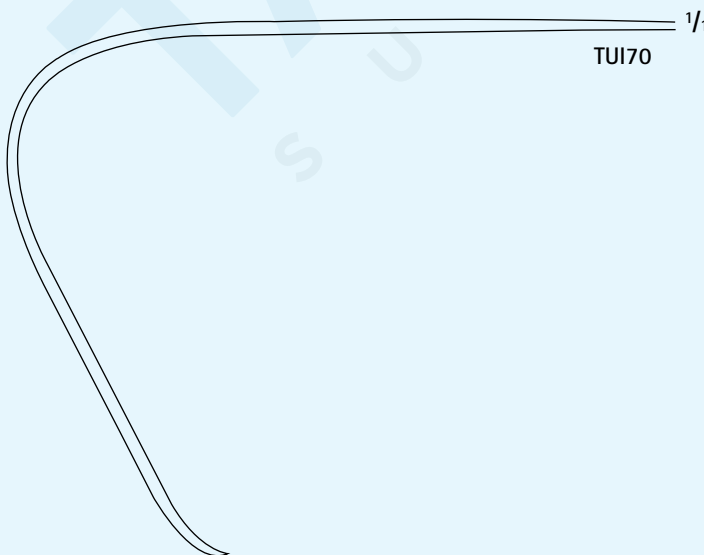

1/1

TUI70



TUI71-TUI78

1/2

GIL VERNET Vein Retractor

Catalog Number	Blade Size (mm)	Length (in.)
TUI71	10 x 4	9 1/2
TUI72	10 x 6	9 1/2
TUI73	10 x 8	9 1/2
TUI74	10 x 11	9 1/2
TUI75	13 x 15	9 1/2
TUI76	13 x 17	9 1/2
TUI77	14 x 20	9 1/2
TUI78	16 x 23	9 1/2

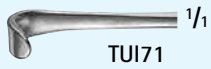

TUI71



TUI72



TUI73

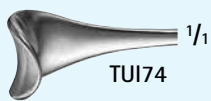

TUI74

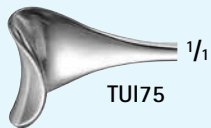

TUI75



TUI76



TUI77



TUI78

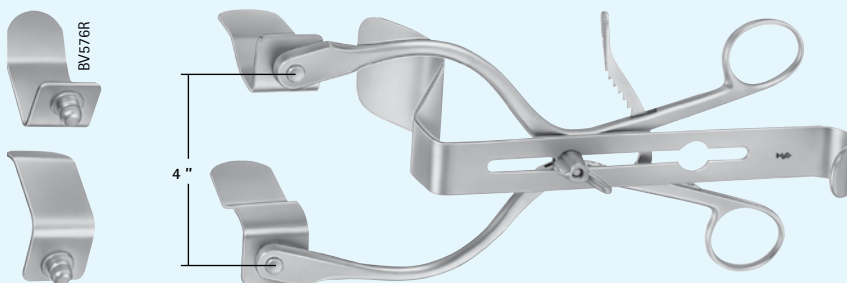

TUI79-TUI83

MILLIN Bladder Retractor

Catalog Number	Description
TUI79	COMPLETE SET
TUI80	SPREADER
TUI81	BLADES, 57 x 25 MM
TUI82	BLADES, 82 x 25 MM
TUI83	CENTER BLADE, 105 x 45 MM

TUI79 Includes:

1 Spreader TUI80

1 Center Blade TUI83

2 Blades of each TUI81 and TUI82

Female Catheter, Metal

Catalog Number	Tip Size (FR)	Length (in.)
TUI84	6	6 1/4
TUI85	8	6 1/4
TUI86	10	6 1/4
TUI87	12	6 1/4
TUI88	14	6 1/4
TUI89	16	6 1/4
TUI90	18	6 1/4



GUYON Wire Catheter Guide, Rigid

Catalog Number	Blade	Tip Size (FR)	Length (in.)
TUI91	CVD	7	14 3/8

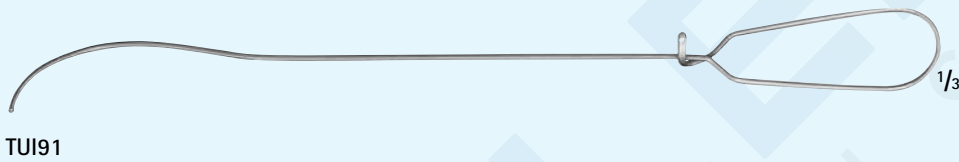

JEWETT Urethral Sound

Catalog Number	Tip Size (FR)	Shape	Length (in.)
TUI92	12	STR	9 1/2
TUI93	14	STR	9 1/2
TUI94	16	STR	9 1/2
TUI95	18	STR	9 1/2
TUI96	20	STR	9 1/2
TUI97	22	STR	9 1/2
TUI98	24	STR	9 1/2
TUI99	26	STR	9 1/2
TUI100	28	STR	9 1/2
TUI101	30	STR	9 1/2
TUI102	32	STR	9 1/2

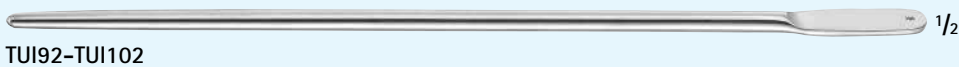

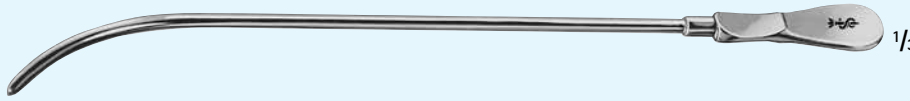

TUI103-TUI125

DITTEL Urethral Sound

Catalog Number	Tip Size (FR)	Length (in.)
TUI103	8	13 1/2
TUI104	9	13 1/2
TUI105	10	13 1/2
TUI106	11	13 1/2
TUI107	12	13 1/2
TUI108	13	13 1/2
TUI109	14	13 1/2
TUI110	15	13 1/2
TUI111	16	13 1/2
TUI112	17	13 1/2
TUI113	18	13 1/2
TUI114	19	13 1/2
TUI115	20	13 1/2
TUI116	21	13 1/2
TUI117	22	13 1/2
TUI118	23	13 1/2
TUI119	24	13 1/2
TUI120	25	13 1/2
TUI121	26	13 1/2
TUI122	27	13 1/2
TUI123	28	13 1/2
TUI124	29	13 1/2
TUI125	30	13 1/2



TUI126-TUI134

CAMPBELL Miniature Sound

Catalog Number	Tip Size (FR)	Length (in.)
TUI126	6	9 1/2
TUI127	8	9 1/2
TUI128	10	9 1/2
TUI129	12	9 1/2
TUI130	14	9 1/2
TUI131	16	9 1/2
TUI132	18	9 1/2
TUI133	20	9 1/2
TUI134	22	9 1/2

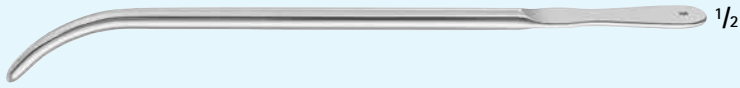

TUI135-TUI149

MCCREA Urethral Sound, Infant/Female

Catalog Number	Tip Size (FR)	Length (in.)
TUI135	8	7 1/4
TUI136	10	7 1/4
TUI137	12	7 1/4
TUI138	14	7 1/4
TUI139	16	7 1/4
TUI140	18	7 1/4
TUI141	20	7 1/4
TUI142	22	7 1/4
TUI143	24	7 1/4
TUI144	26	7 1/4
TUI145	28	7 1/4
TUI146	30	7 1/4
TUI147	32	7 1/4
TUI148	34	7 1/4
TUI149	36	7 1/4

VAN BUREN Urethral Sound

Catalog Number	Tip Size (FR)	Length (in.)
TUI150	8	10 5/8
TUI151	10	10 5/8
TUI152	12	10 5/8
TUI153	14	10 5/8
TUI154	16	10 5/8
TUI155	18	10 5/8
TUI156	20	10 5/8
TUI157	22	10 5/8
TUI158	24	10 5/8
TUI159	26	10 5/8
TUI160	28	10 5/8
TUI161	30	10 5/8
TUI162	32	10 5/8
TUI163	34	10 5/8
TUI164	36	10 5/8
TUI165	38	10 5/8
TUI166	40	10 5/8

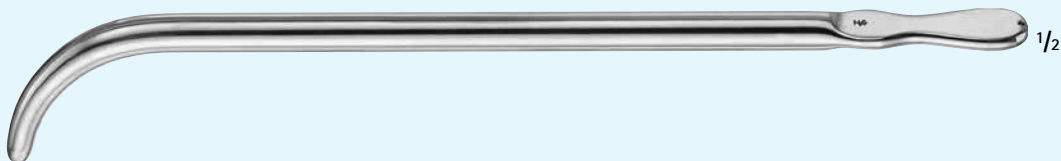

TUI150-TUI166



TUI167-TUI180

WALTHER Dilator-Catheter

Catalog Number	Tip Size (FR)	Length (in.)
TUI167	12	5 1/4
TUI168	14	5 1/4
TUI169	16	5 1/4
TUI170	18	5 1/4
TUI171	20	5 1/4
TUI172	22	5 1/4
TUI173	24	5 1/4
TUI174	26	5 1/4
TUI175	28	5 1/4
TUI176	30	5 1/4
TUI177	32	5 1/4
TUI178	34	5 1/4
TUI179	36	5 1/4
TUI180	38	6

OTIS Bougies a Boule, Olive Tip

Catalog Number	Tip Size (FR)	Length (in.)
TUI181	8	10
TUI182	10	10
TUI183	12	10
TUI184	14	10
TUI185	16	10
TUI186	18	10
TUI187	20	10
TUI188	22	10
TUI189	24	10
TUI190	26	10
TUI191	28	10
TUI192	30	10
TUI193	32	10
TUI194	34	10
TUI195	36	10
TUI196	38	10
TUI197	40	10



TUI181-TUI197





Sialkot, Pakistan Office

Contact Person: Hasham khalid



Address: A/1, Small Industries Estate, Near SIE Telephone Exchange PTCL, Sialkot – Punjab 51310, Pakistan.



Yakshan Khalid: +92 331 478 6083



info@tsurgicalinstruments.com
Talentsurgicalaustralia@gmail.com



Australia Office:

Contact Person: Hasham khalid



Pelham Crescent, Wyndham Vale, VIC 3024 Australia



Hasham Khalid: +61 430 855 424 / +61 481 335 786



info@tsurgicalinstruments.com
Talentsurgicalaustralia@gmail.com



TALENT
S U R G I C A L

